

11A Accessibility Standards Frequently Asked Questions for Residential Projects



Faruk Sezer, PE, CASp-659

Preface

This document is intended to provide information and technical guidance to assist owners, designers and developers with accessibility regulations of the State of California in covered multifamily dwellings subject to **11A Standards**.

It is not the intent of this informal document, to provide any advice on the application of building code regulations to any specific conditions or project with text or illustrations. The pictures and figures presented in this document are shown to illustrate and explain a specific code requirement. It is highly recommended that the actual governing code and regulations be consulted for accessibility requirements applicable to any specific conditions or projects. Actual compliance shall be verified during the plan check process.

The user of this guideline is hereby advised to consult with a California licensed architect or a California Certified Access Specialist (CASp) for evaluation and application of accessibility regulations to any project under consideration.

Note: Covered multifamily dwellings may be subject to the requirements of more than one jurisdiction or law, which would require compliance with each law. Where federal, state, or local laws differ, the more stringent requirements is applicable. For additional information, see the joint statement issued on April 30, 2013 by the Department of Housing and Urban Development and the Department of Justice (www.hud.gov).

1. Does 11A Housing Accessibility Standards require fully accessible units?

No, the 11A Housing Accessibility requirements do not require fully accessible units. However, the requirements shall be easily adapted by people with disabilities who require features of accessibility. See definition of “Adaptable”.

2. Does 11A Housing Accessibility Standards apply to existing buildings containing [covered multifamily dwellings](#)?

Alterations, rehabilitation, or repair of covered multifamily dwellings are not covered because the standards design and construction requirements only apply to new construction of buildings, built for first occupancy after March 13, 1991.

However, a covered multifamily dwelling that has been constructed to comply with the law, cannot later be altered to make it non-compliant with the law.

Additions of 3 or more apartment units, or four or more condominiums are covered by the design and construction requirements

3. Does 11A Housing Accessibility Standards apply to detached, single-family dwellings or duplexes?

No, the 11A Housing Accessibility standards apply to all newly-constructed [covered multifamily dwellings](#), including but not limited to:

- Apartment buildings with 3 or more dwelling units
- Condominiums with 4 or more dwelling units

4. What is a [public housing project](#)?

Public housing is a defined term under Chapter 2 of the CBC and LABC.

Housing facilities owned, operated, or constructed by, for, or on behalf of a public entity, including but not limited to state code section.

5. When is a covered multifamily project subject to [public housing](#) requirements?

Public housing is a defined term as per Chapter 2 of the LABC and CBC.

If a state or local government enters into an agreement with a private party in order to provide housing, then the project shall comply with public housing requirements.

Examples of public housing projects include:

- Projects receiving the California Tax Credit Allocation Committee (TCAC)
- Projects receiving federal, state, or local funds to provide low income housing units.
- Programs that provide shelter for homeless people.

Example of housing projects that are exempt from Public housing requirements include:

- A project receiving a local government subsidy, in order to replace windows and doors
- A program that requires a fund to remove asbestos from the property.

See also the memo issued by DSA on May 22, 2017 in Public Housing

<http://www.treasurer.ca.gov/ctcac/compliance/memos/applicability-building-code-accessibility.pdf>

6. Can you provide examples of “Newly-Constructed Covered multifamily dwelling” types?

Newly-constructed covered multifamily dwellings as defined in 11A Housing Accessibility standards, include, but are not limited to, the following CBC Chapter 11A Section [\[1102A\]](#):

- I. Apartment buildings with 3 or more dwelling units including timeshare apartments not considered a place of public accommodation or transient lodging, as is defined in Health and

Safety Code Section 19955 (a) and Chapter 2 of the California Building Code.

- II. Condominiums with 4 or more dwelling units including timeshare condominiums not considered a place of public accommodation or transient lodging as defined in Health and Safety Code Section 19955 (a), and Chapter 2 of the California Building Code.
- III. Lodging houses, as defined in Chapter 2 of the California Building Code, used as a residence with more than 3 but not more than 5 guest rooms.
- IV. Congregate residences, as defined in Chapter 2 of the California Building Code, with 3 or more sleeping units.
- V. Dwellings with 3 or more efficiency units, as defined in Chapter 2 of this code, or Section 17958.1 of the California Health and Safety Code.
- VI. Shelters for homeless persons, not otherwise subject to the disabled access provisions of the Division of the State Architect-Access Compliance (DSA-AC).
- VII. Dormitories, as defined in Chapter 2 of this code, with 3 or more guest rooms as defined in Chapter 2 of the California Building Code.
- VIII. Timeshare dwellings with 3 or more units, not considered a place of public accommodations or transient lodging as defined in Health and Safety Code Section 19955 (a), and Chapter 2 of the California building Code.
- IX. Other Group R occupancies in covered multifamily dwellings which are regulated by the Office of the State Fire Marshal. See Section 1.11.
- X. **Public housing**, as defined in Chapter 2 of this code is subject to provisions of the Division of the State Architect (DSA-AC) in Chapter 11B. Newly constructed covered multifamily dwellings, which can also be defined as **public housing**, shall be subject to the requirements.

7. Am I obligated to comply with federal accessibility requirements, in addition to state and local jurisdiction accessibility standards?

Yes, it is the responsibility of the Owner and/or applicant, to comply to federal accessibility requirement.

8. Does federal housing accessibility requirements apply to newly constructed covered multifamily dwellings? If yes, what agency reviews plans for federal accessibility requirements?

Yes, federal agencies do not have the mechanism to review plans. The burden of compliance rests with the person or persons who designed and constructed the covered multifamily dwellings.

9. What kind of housing is covered by the 11A Housing Accessibility requirements?

Covered multifamily dwelling units with three or more apartment units or four or more condominiums in one building, that have been designed and constructed since March 13, 1991. This includes, but are not limited to condominiums, townhouses, apartment buildings, vacation or other time share units, assisted living projects, [public housing](#) projects, dormitories, shelters for homeless persons, dwellings with 3 or more efficiency units, lodging houses

10. Do the 11A Housing Accessibility standards apply to Carriage units.

No, carriage units are exempt from 11A accessibility requirements as long as it meets the definition of a Carriage unit per Chapter 2 of LABC.

CARRIAGE UNIT. [HCD 1-AC] A dwelling unit with living space on one or more floors, immediately above a Group U, private garage or garages. The footprint of the garage or garages is used as the footprint for the remaining floor or floors of the units above, and the garage level, contains no Habitable space.

Note: Dwelling units located over a common garage shall not be considered carriage units.

11. I am proposing five new single story apartment units. Shall all of the units need be accessible?

All units are covered multifamily dwellings and all the units are ground floor units, therefore, all five units shall be accessible and adaptable. Apartments with 3 or more units and condominiums with 4 or more units are subject to 11A STD's [\[1102A\]](#).

12. Can an elevator in a building serve just some select units?

An elevator that is installed in a building and that serves one or more units makes the building an elevator building. All units in an elevator building must comply with **11A housing accessibility standards** [\[1104A\]](#).

An exception to this general rule, occurs when an elevator is provided only as a means of creating an accessible route to dwelling units on a ground floor. In that case, the elevator is not required to serve dwelling units on floors that are not ground floors, and the building is not considered to be an elevator building. Only the ground floor units served by this elevator are required to meet the guideline requirements.

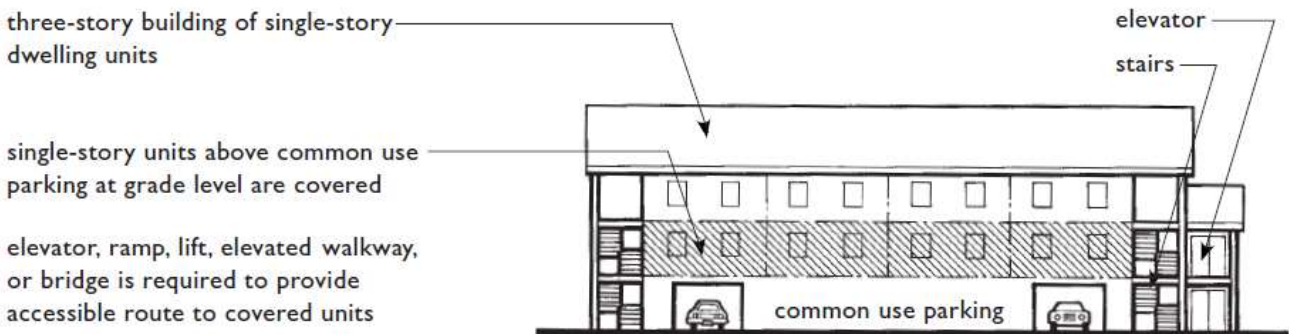

Note: if the elevator is also taken to the next level, the building becomes a building with one or more elevators and all floors and units must comply.

Walk-Up Dwelling Units Over Garages, Shops, and Other Public or Common Use Spaces Are Covered

13. Are the newly constructed, common use areas, such as, common pools and gymnasium, required to be accessible under 11A Housing Accessibility standards provided that such uses are for residents and their guests?

If the original building built contains multifamily units and is built for the first occupancy before March 13, 1991, then there are no [covered multifamily dwellings](#) on site, therefore, newly constructed common areas are not required to be accessible under 11A Housing Accessibility standards [\[1101A.2\]](#).

If however, the building is built for the first occupancy after March 13, 1991, then there are covered multifamily dwelling on site, therefore, newly constructed common areas are required to be accessible [\[1101A\]](#).

14. If new covered multifamily dwellings are added to housing that was constructed before March 13, 1991, do the public or common use areas have to be retrofitted to be accessible?

No, although new covered multifamily dwellings constructed after March 13, 1991 have to comply with the Act's access requirements, public and common use areas constructed before that date do not have to be modified to comply with the 11A Housing Accessibility standards. This is due to existing common use areas built prior to 1991 were never intended to be accessible when built [\[1102A.2\]](#).

15. There is an existing one story duplex building built prior to 1991 and proposed work is to install three new units on top of an existing duplex building. Shall any of the units be accessible?

Proposed work is an addition three units apartment building.

Therefore, all three units shall have an accessible route and shall be adaptable and accessible [\[1101A.1\]](#) [\[1102A.2\]](#).

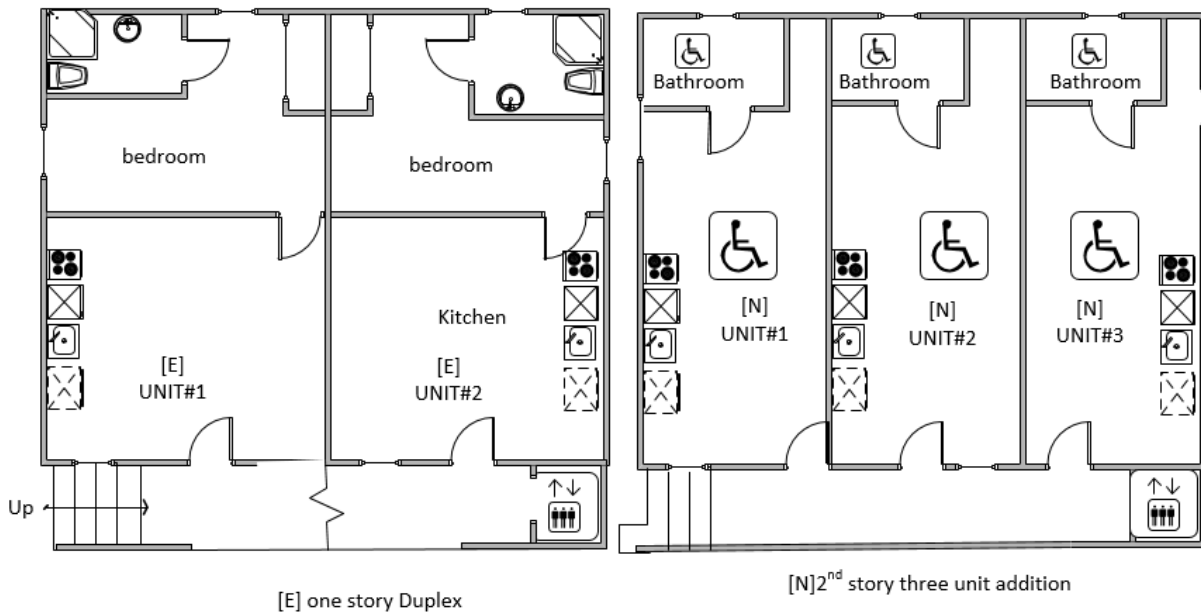

16. Can a unit have a raised or a sunken living room, and still be compliant with the 11A Housing Accessibility requirements?

Yes, as long as the raised, or sunken living room is located on an accessible route [\[1128A\]](#).

17. I am proposing a 3 story, 13 units, townhouse style apartment building. On the ground level there will be a private garage, and on the second floor there will be kitchen and a bathroom, and on the 3rd level there will be bedrooms. Do I need to provide accessible units?

Yes. This is a building with Multistory dwelling units without an elevator.

At least 10% of units shall be in compliance that is 10% of 13.

Therefore, 2 units shall be provided that shall comply [\[1102A.3\]](#) with the following:

- The primary entry shall be on an accessible route
- At least one powder room or bathroom shall be on the primary level
- All rooms or spaces located on the primary entry level shall be on accessible route

- Common use areas shall be on an accessible route [\[1102A.3\]](#).
- **Exemption:** Carriage units as defined in Chapter 2 and regulated only by the Department of Housing and Community Development as referenced in Section 1.8.2.1.2.

18. Are the additions subject to 11A housing accessibility standards?

Additions are subject to 11A housing accessibility standards where the addition itself meets the definition of a Covered multifamily Dwelling.

For example: If the site has an existing 2 units building and the proposed work is to add 3 single story units, then subject 3 units shall be accessible and adaptable [\[1102A.2\]](#).

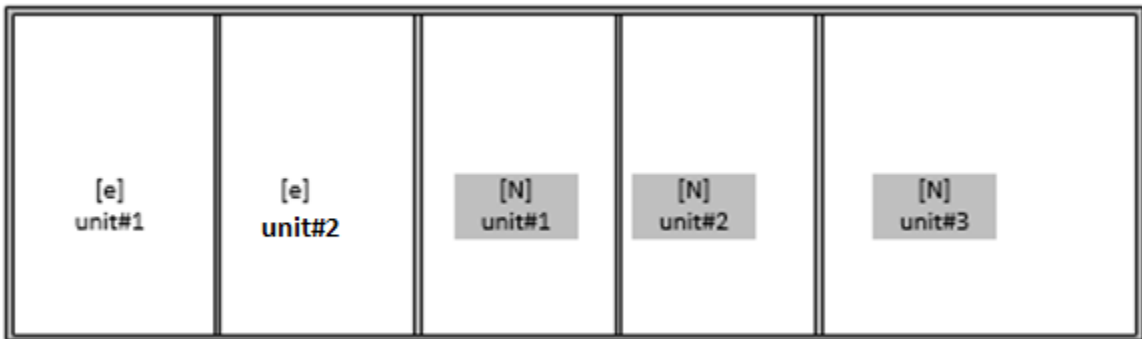

19. For the same example above #18, How many units shall be accessible and adaptable if said newly added units are two story units(Multistory units)?

Only 10% of three, that is one unit shall be accessible and adaptable since the building is non elevator building and units are Townhouse style units [\[1102A.3\]](#).

20. Proposed work is to have brand new eight duplexes (two units in each building) and there will be common use areas, such as, a swimming pool, recreational room, and Gym for residents and their guest. Shall common use areas be accessible?

Single family units and duplex units, are not covered multifamily units, therefore, common use areas serving duplex units are exempt

from the 11A standards as long as the common use areas are used exclusively by residents and their guests [\[1102A\]](#) [\[1101A\]](#).

21. There is an [e] commercial office building and proposed work is to convert [E] office space into a 10 unit apartment building. Shall all 10 units be accessible?

No. [E] Building is built as office for the first occupancy and it is not a newly constructed covered multifamily dwelling therefore conversion of [e] office to an apartment is not subject to 11A Standards unless entire inside walls are demolished and exterior is preserved [\[1101A.1 item #1&5\]](#).

22. Do the CBC accessibility requirements apply to alteration or renovation of properties?

The building standards contained in CBC 11A do not apply to the alteration, repair, rehabilitation or maintenance of multifamily dwellings constructed for first occupancy prior to March 13, 1991. However, a covered multifamily dwelling that has been constructed to comply with the law cannot later be altered to make it non-compliant with the law. [\[1102A.2\]](#).

23. How are 10% of units calculated per site? For example, having six buildings and each building has 4 units, totaling 24 units on site? Does the 10% rule apply to a site or is it per building?

The 10% rule applies to a site and is not per building. In the case above, only 10% of 24 which is 3 units, shall comply with 11A Standards [\[1102A.3\]](#).

24. What are the requirements for multi-story building containing multi-story units where building contains an elevator?

Multi-story dwelling units contained in buildings with elevators shall comply with following. [\[1102A.3.2\]](#).

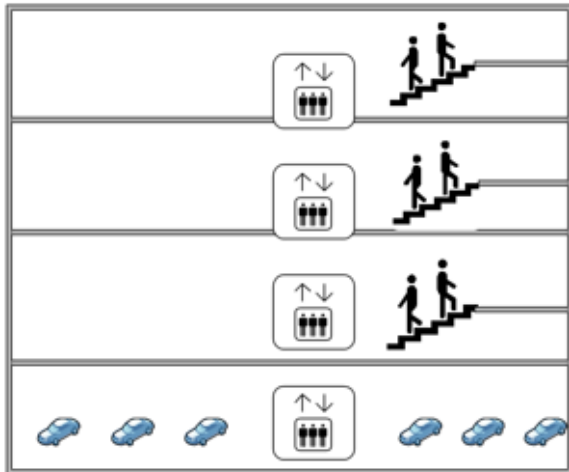

- At least one kitchen, one powder room or bathroom shall be located on the primary level
- All rooms or spaces located on the primary entry level shall be on accessible route

25. I am proposing 2 story apartment building. On the ground level there will be a common garage and on the second floor there will be apartment units. Do I need to install an elevator from garage level to the ground level of the units located on the second floor?

Yes. All units shall be served by an accessible route [\[1104A.2\]](#).

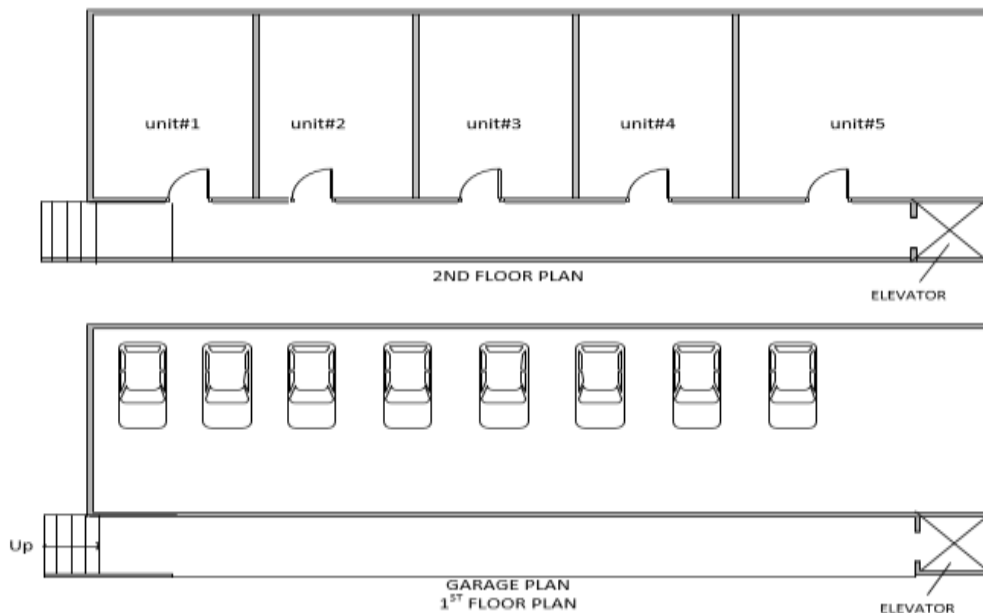

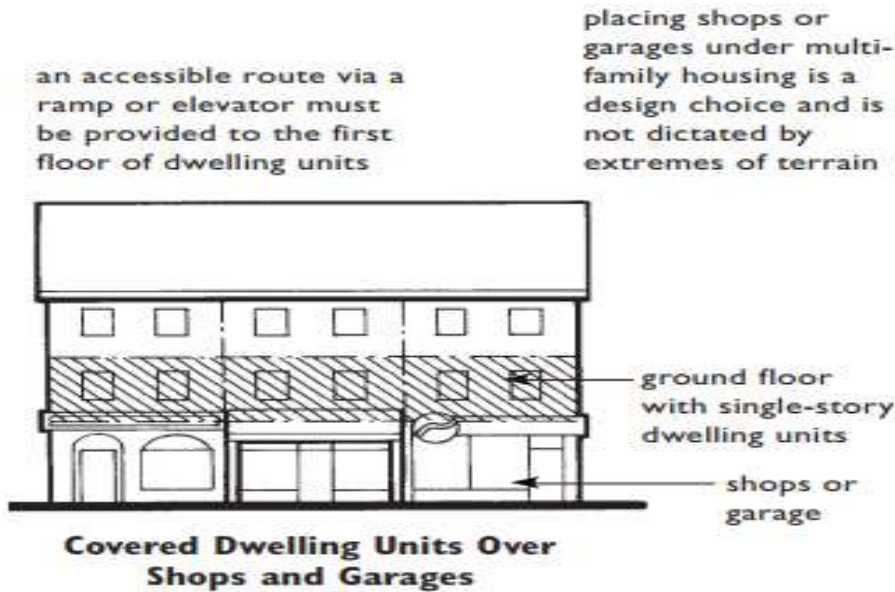

26. I am proposing new roof top deck. Do I have to extend the elevator to roof deck even though I am providing open space on other location of the properties?

When provided, common use areas and facilities in covered multifamily housing developments shall be accessible to persons with disabilities. Common use facilities include, but are not limited to, lobbies, toilet and bathing facilities, laundry facilities, community rooms, clubhouses, health and fitness facilities, game rooms and portions of common use tenant storage. All entrances, doors, fixtures and controls shall be on an accessible route.

27. Do I have to include an elevator that goes to the roof deck if the roof deck is only used for mechanical access purposes?

No, an elevator is not required to a roof deck unless the roof deck is used as common open space [\[1101A.1\]](#).

28. Is a lift permitted as a part of accessible route?

Yes, a lift is permitted to be a part of an accessible route. Once provided it shall comply with size, landing, standby power, openness door and signage requirements [\[1124A.11\]](#).

29. Shall a new swimming pool that is added to existing apartment building be accessible?

If the original building is built for the first occupancy prior to March 13, 1991, the building is not a covered multifamily dwelling and proposed pool is not subject to Standards.

If however the building is built after 1991, The building is a covered multifamily dwelling and proposed pool shall be accessible [\[1101A\]](#), [\[1102A.2\]](#).

Note: Any use open to the public is subject to provisions of the Division of the State Architect (DSA-AC) in Chapter 11B.

30. Are garbage dumpsters required to be on an accessible route under CBC 11A?

Yes, garbage dumpster shall be on accessible route [\[1127A.1\]](#).

31. How many parking spaces shall be accessible in a housing projects?

Accessible parking spaces shall be provided at a minimum rate of 2% of units, or 2% of the assigned parking spaces, whichever larger.

For example, if the site has 50 units and 75 parking spaces, 2% of 75 is 1.5. The calculated fractional spaces shall be round up, therefore a minimum of 2 accessible spaces are required, one of which shall be Van Accessible [\[1109A.3, 1109A.4, 1109A.8.6\]](#).

32. Does the code require additional parking spaces for visitors or guests? If so, what is the minimum required parking rate?

If the site has assigned parking spaces for residents as well as visitor parking spaces, accessible parking spaces are required for each type. Parking rate for the visitors are at 5%.

For example; if the site has 75 assigned parking spaces and 8 visitor parking spaces, total of 2% of 75 equal to 2 spaces for the residents, and 5% of 8 equal to 1 space for visitor is required, totaling 3 accessible spaces that are required for the site [\[1109A.3, 1109A.4, 1109A.5\]](#).

33. If I am providing a valet parking service, am I still required to provide 2% accessible parking spaces for covered multifamily dwellings?

Yes, a minimum of 2% of the parking spaces that serve covered dwelling units must be accessible

34. I am planning to convert my existing apartment building into a condominium and city planning requires additional visitor parking spaces. Do I have to provide additional accessible visitor parking spaces?

If the original building is built for the first occupancy after March 13,1991, the building is covered multifamily dwelling and additional visitor accessible parking spaces are required with a rate of 5% [\[1109A.5\]](#).

35. Is there any standards in 11A for location of parking spaces?

Yes, the standards require that parking spaces shall be on the shortest accessible route and shall be located so that persons with disabilities are not compelled to wheel or walk behind other cars other than their own [\[1109A.7\]](#).

In addition, accessible parking spaces shall have vertical clearance, slope and size requirements [\[1109A.8.1, 1109A.8.3, 1109A.8.4, 1109A.8.5\]](#).

36. How many van accessible spaces are required?

In a housing project, one per eight accessible spaces, but not less than one accessible space, shall be van accessible. Loading and unloading space shall be on the right, passenger side [\[1109A.9.8.6\]](#).

37. If the proposed work is a mixed use project, how is parking count calculated?

Parking shall be calculated separately for each use.

38. What is the height requirements for a vertical clearance in a garage or carport?

All entrances, exits, and vehicular passageways, to and from required accessible parking spaces within parking facilities, shall have a minimum vertical clearances of 8 feet 2 inches (98”) from the floor to the lowest projection of the ceiling. This 98” shall be clear of any plumbing pipes, sprinkler head or obstruction at ceiling [\[1109A.8.1\]](#).

39. What are the accessible parking size requirements in residential apartment projects?

- Single spaces shall be 14 feet (4267 mm) wide minimum, and shall provide a 9-foot (2743 mm) wide parking area and a 5-foot (1524 mm) wide loading and unloading access aisle. Access aisles shall be permitted to be located on either side of the vehicle and shall extend the full required length of the parking spaces they serve [\[1109A.8.5\]](#), [\[1109A.8.6\]](#).

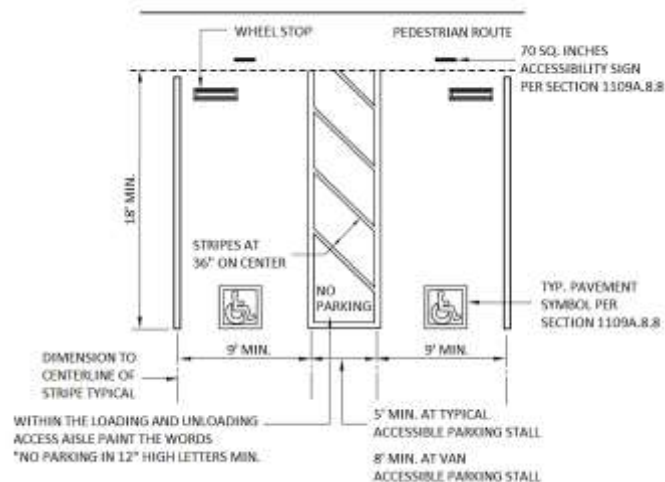

- When more than one space is provided, two 9-foot (2743 mm) wide parking spaces may be lined on each side of a 5-foot (1524 mm) wide loading and unloading access aisle.
- The minimum length of each parking space shall be 18 feet (5486 mm).
- The loading and unloading access aisle shall be marked by a border painted blue. Note: See Figure 6 from 11A-2A, 11A-2B and 11A-2C of building code.

40. Are there any signage requirements for parking?

Each accessible parking space shall be identified with signage and surface markings in accordance with Sections [\[1109A.8.8.1\]](#) and [\[1109A.8.8.2\]](#).

However, when assigned parking is provided, signage shall not be required [\[1109.4\]](#).

41. What is the minimum accessible route requirements required for residential projects?

Walkways and sidewalks subject to 11A standards shall be a minimum of 48" in width, except those walkways serving the unit which shall be a minimum of 36" [\[1113A\]](#).

42. What is the difference between a walk and a ramp?

- A. Ramp is a walking surface that has a running slope that is greater than 1 unit vertical in 20 units horizontal. (5% slope), and less than 1 unit vertical in 12 units horizontal (8.33 % slope).
- B. Ramp requires a top and bottom landing and handrail extensions on each side additionally, there are requirement for ramp width and run height [\[1114A\]](#).

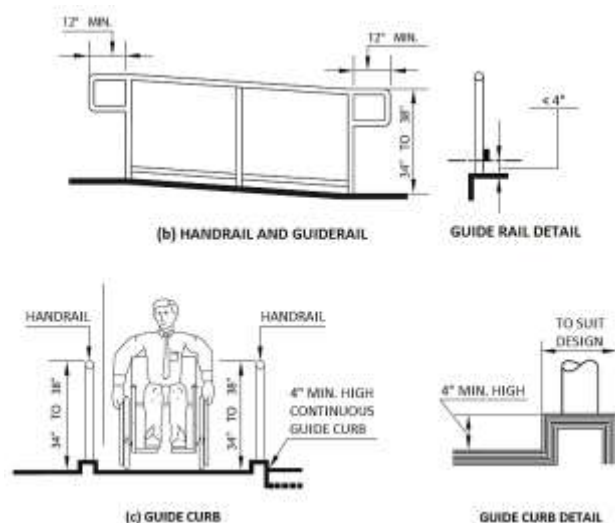

43. Can you provide some example of ramp dimensions?

SLOPE (Grading %)	MAXIMUM RISE (Inches)	MAXIMUM HORIZONTAL PROJECTION (Feet)
	(x 25.4 for mm)	(x 304.8 for mm)
1:12 (8.33%)	30	30
1:15 (6.67%)	30	37.5
1:16 (6.25%)	30	40
1:20 (5.00%)	30	50

44. What is the minimum headroom clearance required on an accessible route?

80" is the minimum headroom clearance required [\[1116A.2\]](#).

Note: See Chapter 10 Means of Egress for additional requirements.

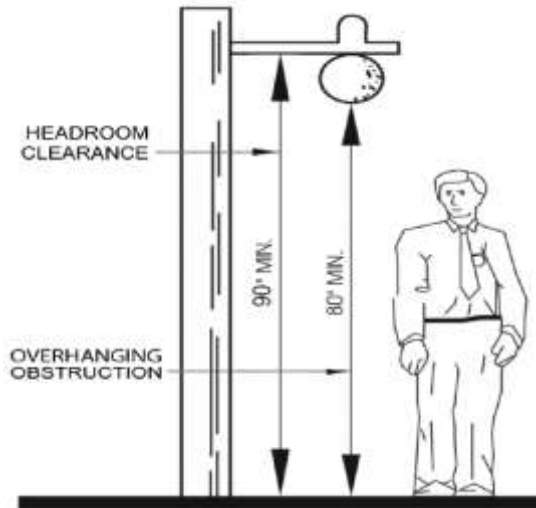

45. Is a Spa covered under 11A for Covered multifamily dwellings?

A spa meets the definition of a swimming pool per Chapter 2 of the LABC as it states, " Any structure intended for swimming, recreational bathing, or wading that contains water over 24" deep..." therefore, the spa shall comply with 11A Standards [\[1141A\]](#) [\[Definition\]](#).

46. What are the requirements for water closet flush controls in bathrooms/ powder rooms within accessible and adaptable units?

There are no standards for water closet flush controls within adaptable units.

47. Where should the required clear openings at doors be measured?

With the door open 90 degrees, the clearance is measured between the face of the door and the opposing doorstop. The primary entrance door to dwellings, and public and common use doors, must be 36" minimum in width and have a 32-inch minimum clear opening. Passage doors within a dwelling must have a nominal 32-inch clear opening [\[1126A.1\]](#), [\[1132A\]](#).

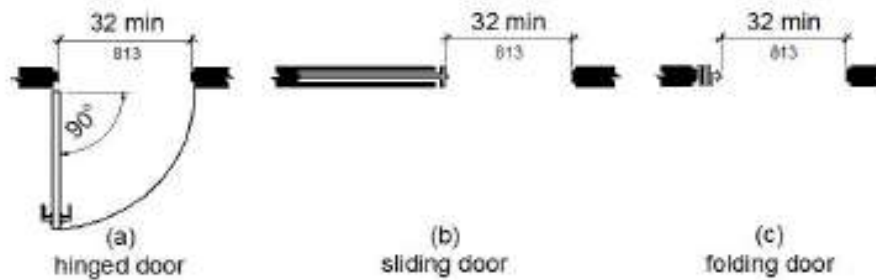

CLEAR WIDTH OF DOORWAYS

48. If a bathroom has more than one entrance door, must all doors comply with access requirements?

Yes, all doors that are for user passage must meet access requirements and provide a nominal 32-inch clear opening [\[1126A.1\]](#), [\[1132A\]](#).

49. Are electrical receptacles switches and control heights, within reach range specified in the code?

Yes. Receptacles, switches shall be accessible and within reach range of 15" minimum measured from bottom of the outlet box to the finish floor or working platform, and 48" maximum measured from the top of the receptacle outlet box [\[1142A\]](#).

If the reach is over a physical barrier or an obstruction (for example, a kitchen base cabinet), receptacles shall be located within the reach ranges specified in Section 1138A.3.

50. What is the maximum threshold at the entrance of an adaptable shower within a covered multi-family unit?

Threshold at a shower is not required, but may be provided. When a threshold is used, it shall be a maximum of 2 inches in height and have a beveled or sloped angle not exceeding 1 unit vertical in 2 units horizontal.

Thresholds 1/2 inch (12.7 mm) or less in height may have a beveled or sloped angle not exceeding 1 unit vertical in 1 unit horizontal [\[1134A.6 item#5\]](#).

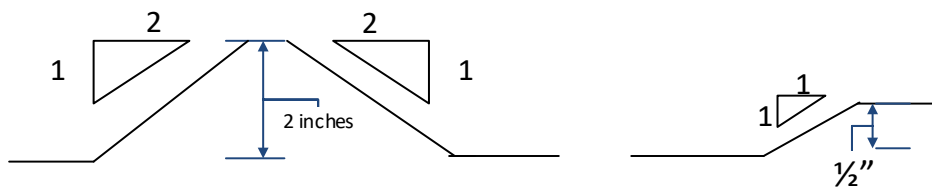

51. Is a doorbell required at primary entry door of a unit? If required, can it be the type that is a battery operated wireless doorbell?

Every primary entrance to a covered multifamily dwelling unit shall be provided with a door buzzer, bell, chime or equivalent. The activating mechanism shall be mounted a maximum of 48 inches (1219 mm) above the floor and connected to permanent wiring [\[1132.A10\]](#).

52. What are the door maneuvering space requirements within a covered multifamily dwelling units' interior doors?

Maneuvering clearances at interior doors shall provide a minimum length on both sides of the door of at least 42 inches (1067 mm), measured at a right angle to the plane of the door in its closed position [\[1132A.5\]](#).

There shall be a minimum of 18" at strike edge maneuvering space at doors [\[1132A.5.2\]](#).

Exception: A 39-inch (991 mm) length is acceptable at interior doors when a minimum clear opening width of 34 inches (864 mm) is provided [1132A.5].

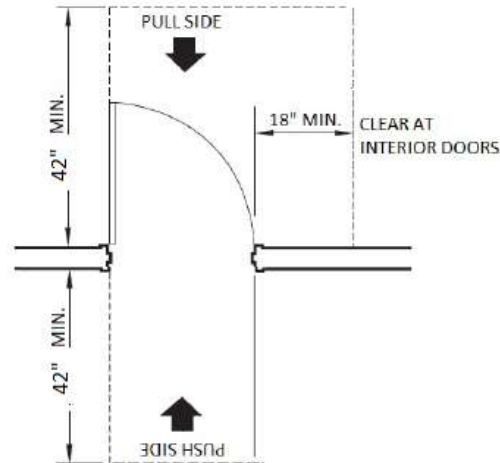

53. What are the basic requirements for kitchens within covered multifamily dwellings?

- Kitchen shall be on an accessible route [1133A.1].
- A clear space of 30"x48" parallel approach shall be provided at the range or cooktop [1133A.2].
- A clear space of 30"x48" parallel or forward approach shall be provided at sink, fixtures, and appliances [1133A.2].
- The clear space shall be center lined with each sink, fixture and appliances [\[1133A.2\]](#).

54. What is the max allowable kitchen counter height?

Max kitchen counter height is 36 inches measured from above the finish floor [1138A.3.2 item#2].

55. Shall removable base cabinets be removable under sink and work space?

Yes, sinks and work surfaces shall be provided with knee and toe space. Base cabinets (including toe board and shelving), directly under kitchen sinks and work surfaces, shall be Removable without the use of specialized tools or specialized Knowledge in order to

provide knee and toe space. The finish floor beneath kitchen sinks and work surfaces shall be extended to the wall [\[1133A.3\]](#).

56. What are the requirements for knee and toe spaces?

Knee and toe space, when required by Section 1133A, shall comply with Section 1138A.2 and the following:

- The knee and toe space shall be clear and unobstructed, or removable base cabinets in compliance with Section 1133A.3 shall be provided.
- The knee and toe space shall be 30 inches (762 mm) wide minimum, centered on the sink, countertop, or appliance.
- A clear floor space shall not extend into the knee and toe space more than 19 inches (483 mm).
- Water supply and drain pipes under kitchen sinks shall be insulated or otherwise covered to protect against contact. There shall be no sharp or abrasive surfaces under kitchen sinks.

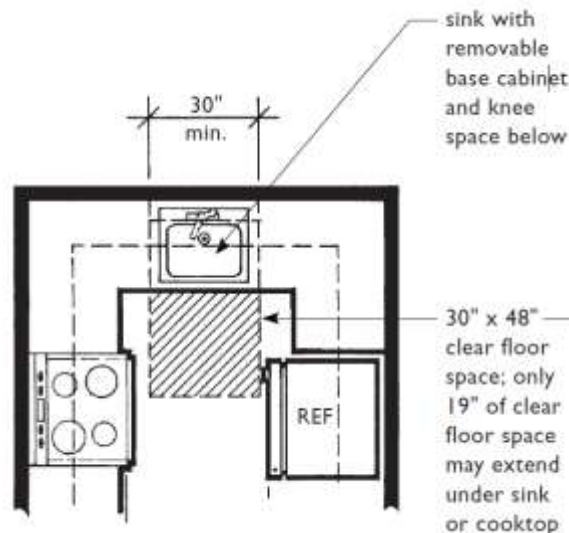

57. How much space do I need for kitchen and work space within covered multifamily dwellings?

- A minimum linear length of 30 inches (762 mm) of countertop shall be provided for the kitchen sink installation.
- A minimum linear length of 30 inches (762 mm) of countertop shall be provided for a work surface.

- Sinks and work surfaces may be a single integral unit a minimum of 60 inches (1524 mm) in length, or be separate components.
Exception: Two 15-inch (381 mm) wide minimum breadboards may be provided in lieu of the required 30 inches (762 mm) of countertop work surface [\[1133A.4\]](#).

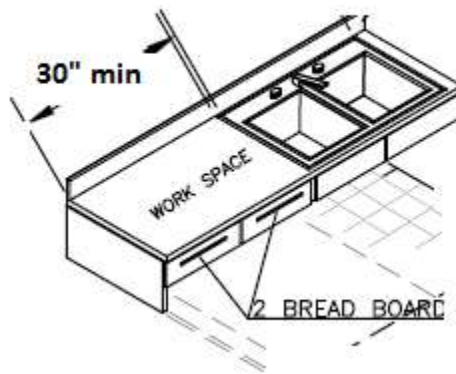

58. How many bathroom shall be in compliance with 11A accessibility standards if more than one bathrooms are provided?

There are two options; [\[1134A\]](#).

Option#1 requires all bathroom to comply with 11A partial list standards.

Option #2 requires at least one bathroom to comply with 11A full list standards. The first bathroom shall have the following:

- Sufficient maneuvering space within the room.
- Bathtubs and shower complying with 1134A.5&1134A.6.
- Water closets complying with section 1134A.7.
- Lavatories, vanities, mirrors and towel fixtures comping with Section 1134A.8.
- Accessible route shall be provided into and throughout additional bathrooms.
- If door is provided, door shall have 42” maneuvering space.
- 18” of strike edge clearance at pull side.
- Switches, outlets, and controls to be within reach range per 1142A.

- Reinforced walls to allow for the future installation of grab bar.

The additional restrooms shall comply with items 8 through 12 per section 1134A.1 which include:

- An accessible route shall be provided into and throughout additional bathrooms.
- If door is provided, door shall have 42" maneuvering space
- 18" of strike edge clearance at pull side.
- Switches, outlets, and controls to be within reachable range per 1142A.
- Reinforced walls to allow for the future installation of grab bar.

59. What is the minimum clear space required for an accessible bathtub within a covered unit?

There shall be a minimum clear floor space of 48 inches parallel by 30 inches perpendicular (1219 mm by 762 mm) to the side of a bathtub or bathtub- shower combination. The purpose is to provide for the maneuvering of a wheelchair and transfer to and from the bathing facilities. The controls shall be on the wall at the foot of the bathtub. The edge of the clear floor space shall be flush with the control wall surface [\[1134A.5\]](#).

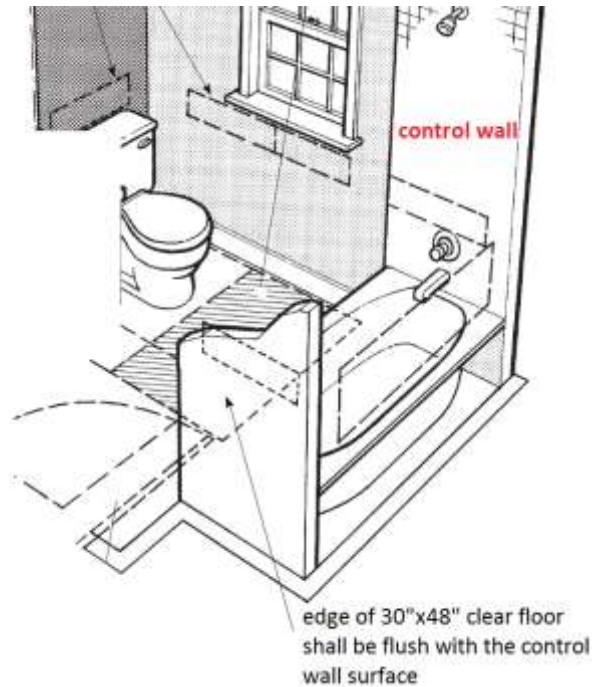

60. Can door swing into clear space required for other fixtures?

Yes, the door can swing over other clear spaces required for each fixture within accessible bathrooms, and powder rooms [\[1134A.4\]](#).

61. Can a water closet, project into required 30"x48" that is clear space that is required for the accessible tub?

Toilets and cabinets under lavatories are NOT permitted to project into clear space required for the tub. However, lavatories without cabinets can project max of 19" into the clear space. [\[1134A.5\]](#)

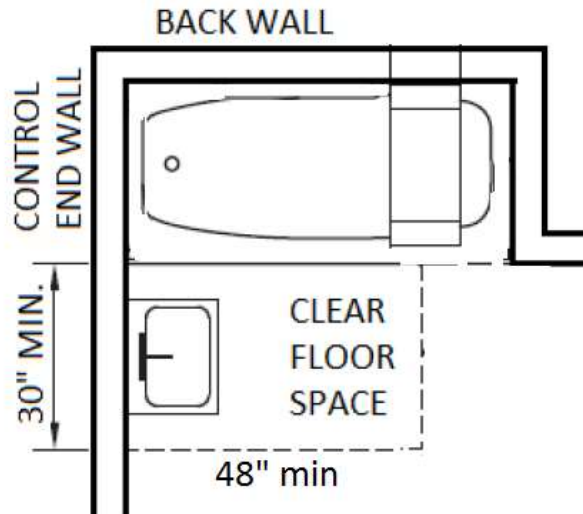

62. What are minimum accessible shower sizes allowed within covered multifamily dwelling units?

When one or more shower stalls are provided within the same dwelling units, at least one shower stall complies with one of the following requirements [\[1134A.6\]](#):

- The shower stall shall measure at least 42 inches wide by 48 inches deep with an entrance opening of at least 36 inches; or
- The shower stall shall measure at least 30 inches deep by 60 inches wide with an entrance opening of at least 60 inches. A water closet may project a maximum of 12 inches into the opening, provided that a minimum of 36 inches clear space is maintained between the water closet and the shower wall, as illustrated in Figure 11A-9L or;

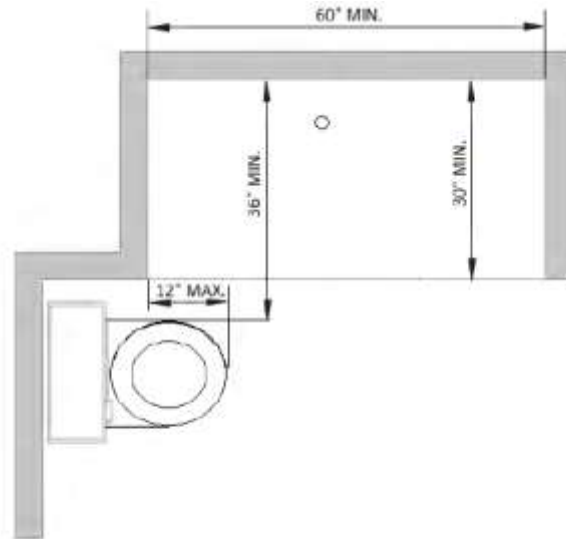

FIGURE 11A-9L
SHOWER WITH WATER CLOSET

- Other shower stall configurations shall measure at least 36 inches deep by 60 inches wide with an entrance opening of at least 36 inches (914.4mm), when a wall is installed on the opening side.

63. Are shower enclosures permitted in accessible showers?

Shower enclosures are permitted however, it shall comply with following:

Showers with or without enclosures shall comply with shower size requirements including the shower opening requirement [\[1134A.6\]](#).

64. What is the minimum clear space required for an accessible shower within a covered unit?

The minimum clearance required for accessible shower in a covered unit on floor space. A clear maneuvering space at least 30 inches in width by 48 inches in length shall be located outside the shower, flush, and parallel to the control wall [\[1134A.6 item #3\]](#).

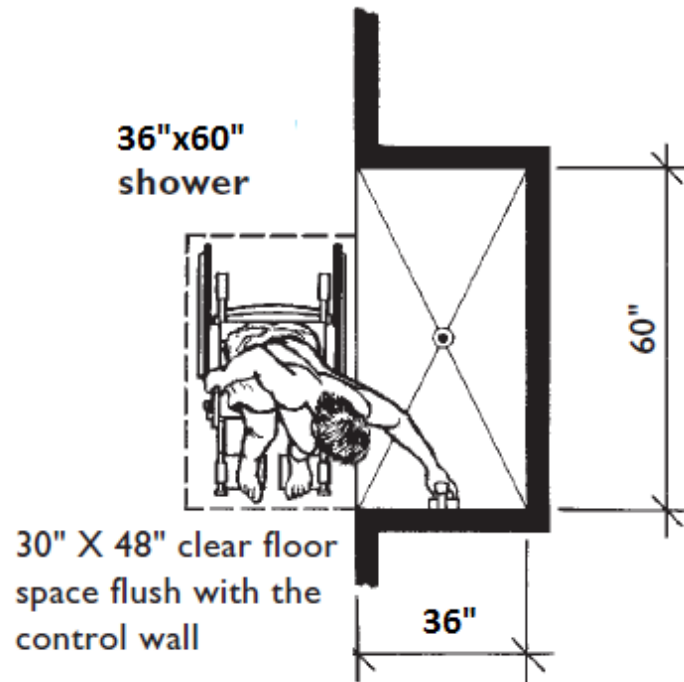

65. Is clear space required for a water closet in accessible bathroom within a covered unit? If so, how is clear space measured?

Minimum clearance width of clear space is 48". It shall extend past the front edge of the water closet at least 36".

The 48-inch (1219.2 mm) minimum clear width may be reduced to 36 inches (914.4 mm) for lavatories, cabinets, wing walls, or privacy walls located immediately adjacent to a water closet that extends no more than 24 inches (610.6 mm) in depth [\[1134A.7\]](#).

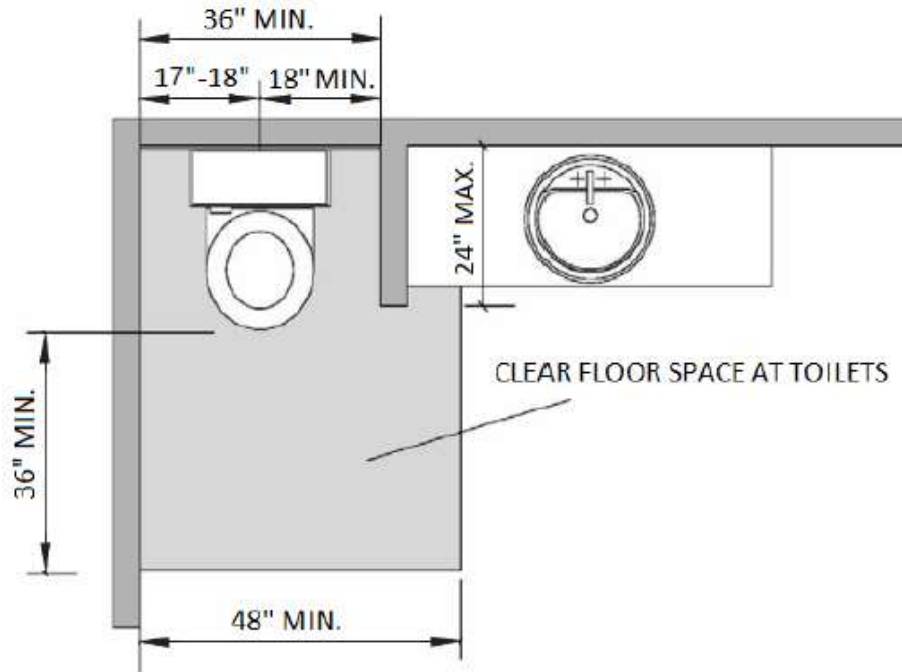

66. What are the accessibility requirements for trash chutes, whether they are built into a corridor wall and accessed from the corridor or located within a separate room that is accessed by a door?

A trash chute is a public and common use facility subject to the standards, it shall comply with [\[1127A.1\]](#):

- Accessible route
- There must be a minimum 30" by 48" clear floor space for either a parallel or forward approach to the trash receptacle.
- The opening of the trash chute door and its hardware must be within compliant reach ranges [1138A.3].
- The trash chute opening must be equipped with usable hardware.
- When a trash chute is located in a separate room that is accessed by a door, the chute is subject to all specifications cited above, in addition to:
 - The door to the room must be accessible, and all applicable sections must comply with the standards
 - Maneuvering space must be provided on both sides of the door.

- There must be enough maneuvering space within the trash chute room to enter, use the chute, approach, open the door, and exit.

67. Are washers and dryers provided in individual units, subject to the 11A Housing Accessibility standards Guidelines?

If clothes washing machines and clothes dryers are provided in covered multifamily dwelling units, one of each type of appliance shall be provided. Where front-loading clothes washers are not provided, management shall provide assistive devices, on request of the occupant, to permit the use of top-loading clothes washers [\[1135A\]](#).

68. Are washers and dryers provided in common areas subject to standards?

Where common use laundry rooms are provided, at least one of each type of appliance provided in each laundry area shall be accessible, shall be on an accessible route and shall comply with the standards [\[1127A\]](#), [\[1127A.10\]](#):

- There shall be a minimum clear space 30 inches (762mm) perpendicular by 48 inches (1219mm) parallel in front of clothes washers and dryers required to be accessible.
- There shall be a minimum clear space 30 inches (762mm) by 48 inches (1219mm) provided for at least one of each type of fixture or appliance provided in the laundry room (e.g. soap dispensers, wash sinks, tables, and storage areas).
- Clothes washers and dryers including stacked clothes washers and dryers required to be accessible shall have controls and operating mechanisms (doors, coin slots, lint screens, detergent, and bleach compartments) within reach range of a seated user.
- Controls and operating mechanisms shall be located no higher than 48 inches (1219mm), and no lower than 15 inches (381mm) above the finished floor measured to the center of the grip.
- Controls and operating mechanisms shall be operable with one hand and shall not require tight grasping, pinching, or twisting of the wrist.

The force required to activate controls and operating mechanisms shall be no greater than 5 pounds (22.2 N).

- Washing machines and clothes dryers in accessible common use laundry rooms shall be front loading.

69. What is the minimum clear width with in a kitchen and how is it measured?

There are three different possible kitchens [\[1133A.2.1\]](#).

1. U-shaped kitchens, designed with parallel approach at a range or cooktop located at the base of the U, shall have a minimum clear width of at least 60 inches (1524 mm). (See Figure 11A)

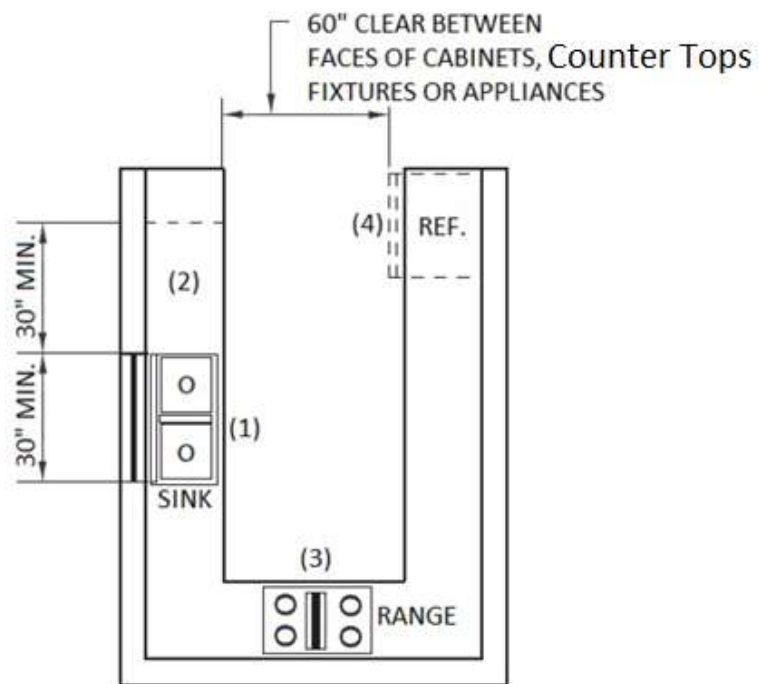

"U" SHAPED KITCHEN WITH RANGE AT THE BASE

Figure 11A

2. U-shaped kitchens, designed with a cooktop or sink located at the base of the U, which provides a knee and toe space in

accordance with Section 1133A.7 to allow for a forward approach, shall have a clear width of at least 48 inches (1219 mm).

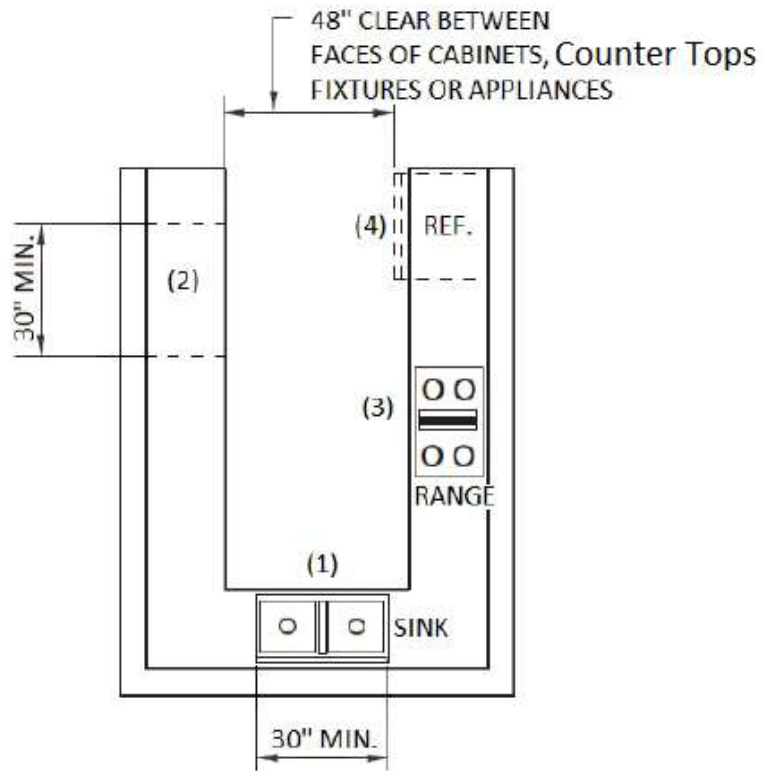

"U" SHAPED KITCHEN WITH SINK AT THE BASE

3. All other kitchen designs shall provide a minimum clear width of at least 48 inches (1219 mm).

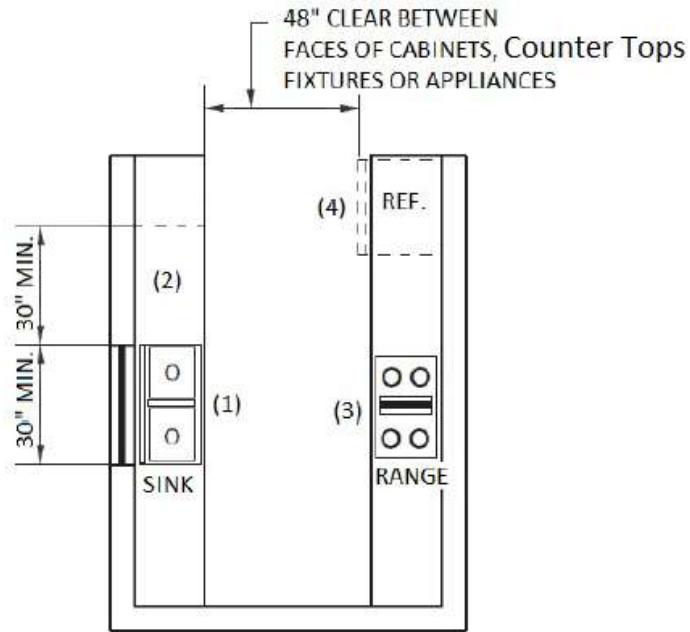

TYPICAL KITCHEN

(1) 30" minimum countertop space for sink installation with removable base cabinet and finish flooring beneath the sink; 30" x 48" minimum clear floor space to allow parallel or forward approach.

(2) 30" minimum countertop for work surface with removable base cabinet and finish flooring beneath; 30" x 48" minimum clear floor space to allow parallel or forward approach.

(3) 30" x 48" minimum clear floor space adjacent to range to allow parallel approach.

(4) 30" x 48" clear floor space at refrigerator, dishwasher, trash compactor or other appliances to allow parallel or forward approach.

70. What are the level landing requirements at doors serving covered multifamily dwellings? [\[1132A.4\]](#)

- Exterior landings of impervious construction (e.g. concrete, brick, flagstone) serving primary entry doors and required exit doors are limited to no more than 1/2 inch (12.7 mm) of change in height between floor surfaces. Changes in level shall comply with Section [1131A.2].
- Exterior landings of pervious construction (e.g. wood decking with spaces) shall be the same level as the interior landing, except that secondary exterior doors may have no more than 1/2 inch (12.7 mm) of change in height between floor surfaces. Changes in level shall comply with Section [1131A].

- Secondary exterior doors onto decks, patios, or balcony surfaces constructed of impervious materials (e.g. concrete, brick, flagstone) may have a maximum change in height from the interior landing of 4 inches (101.6 mm). Changes in height greater than 1/2 inch (12.7 mm) shall be accomplished by means of a ramp complying with Section 1114A or by means of a platform constructed to the level of the floor as illustrated in Figure 11A-8J.

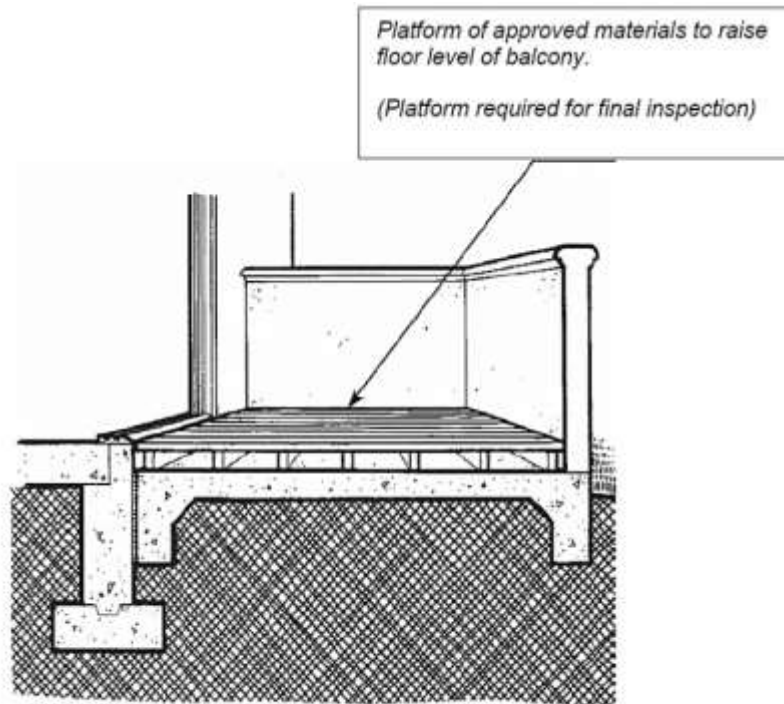
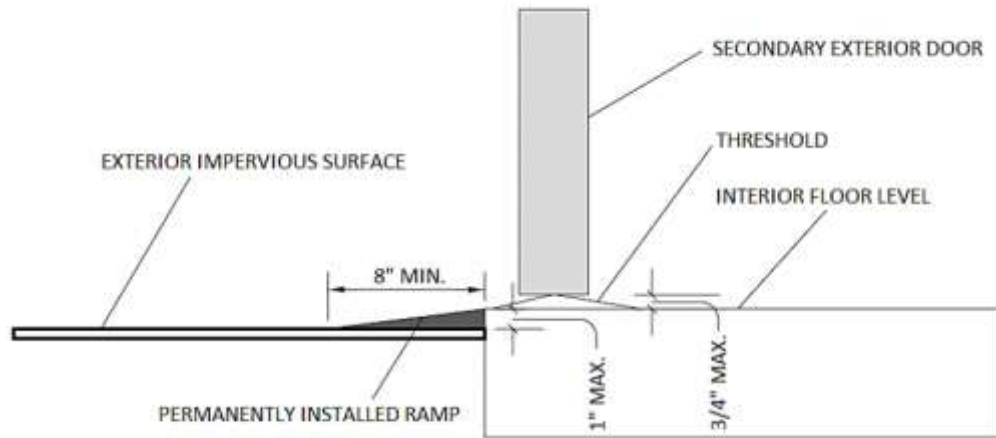

FIGURE 11A-8J
PLATFORM AT SECONDARY EXTERIOR DOOR

- Secondary exterior doors onto decks, patios, or balcony surfaces constructed of impervious materials (e.g. concrete, brick, flagstone) may have a maximum change in height from the interior landing of 1 inch (25.4 mm), provided a ramp with a maximum slope of 1:8 is permanently installed. (See Figure 11A-8K).



**FIGURE 11A-8K
RAMP AT SECONDARY EXTERIOR DOOR**

- In buildings containing covered multifamily dwelling units, the floor or landing immediately outside the entry may be sloped up to 1/4 inch (6.35 mm) per foot (12 inches) (305 mm), in a direction away from the primary entrance of the dwelling unit for drainage.

Summary of Maximum Allowable Height Difference Between Interior Floor Level and Exterior Floor Level		
	At primary entry door and required exit door	At secondary exterior doors at decks, patios or balcony
Impervious construction (e.g., concrete, brick, or flagstone)	1/2 inch(a)	4 inches(b) 1 Inch(c)
Pervious construction (e.g., wood decking with spaces)	0 inch	1/2 inch(a)
Threshold At Doors(d)	1/2 inch	3/4 inch

(a) Changes in level shall comply with Section 1131A.

(b) Changes in height greater than 1/2 inch (12.7 mm) shall be accomplished by means of a ramp complying with Section 1114A or by means of a platform constructed to the level of the floor as illustrated in Figure 11A-8J.

(c) Secondary exterior doors onto decks, patios or balcony surfaces constructed of impervious materials (e.g., concrete, brick, flagstone) may have a maximum change in height from the interior landing of 1 inch (25.4 mm), provided a ramp with a maximum slope of 1:8 is permanently installed. (See Figure 11A-8K.)

(d) Changes in height at interior door thresholds (e.g. floor material changes at door thresholds) shall not exceed 1/2 inch (12.7 mm). Thresholds shall comply with the following:

- *A change in height of not more than 1/4 inch (6.35 mm) may be vertical.*
- *A change in height between 1/4 inch (6.35 mm) and 3/4 inch (19.05 mm) shall be beveled with a slope no greater than 1 unit vertical in 2 units horizontal (50-percent slope).*

COVERED MULTIFAMILY DWELLINGS. [HCD 1-AC] <
“Covered multifamily dwellings” means either of the following:

- 1. Buildings that consist of at least four condominium dwelling units or at least three apartment dwelling units if the buildings have at least one elevator.*
- 2. The ground floor dwelling units in buildings that consist of at least four condominium dwelling units or at least three apartment dwelling units if the building does not have an elevator.*

Covered multifamily dwellings include dwellings listed in Section 1102A.1. For purposes of this definition, dwelling units within a single structure separated by firewalls do not constitute separate buildings.

PUBLIC HOUSING. [DSA-AC & HCD 1-AC] *Housing facilities owned, operated, or constructed by, for or on behalf of a public entity including but not limited to the following:*

- 1. Publically owned and/or operated one- or two-family dwelling units or congregate residences;*
- 2. Publically owned and/or operated buildings or complexes with three or more residential dwelling units;*
- 3. Reserved.*
- 4. Publically owned and/or operated homeless shelters, group homes and similar social service establishments;*
- 5. Publically owned and/or operated transient lodging, such as hotels, motels, hostels and other facilities providing accommodations of a short term nature of not more than 30 days duration;*
- 6. Housing at a place of education owned or operated by a public entity, such as housing on or serving a public school, public college or public university campus;*
- 7. Privately owned housing made available for public use as housing.*

SECTION 1102A BUILDING ACCESSIBILITY

1102A.1 Where required. Buildings or portions of buildings and facilities within the scope of this chapter shall be accessible to persons with disabilities. Each building on a building site shall be considered separately when determining the requirements contained in this chapter, except when calculating the number of units which must comply with Section 1102A.3.1. Dwelling units within a single structure separated by firewalls do not constitute separate buildings.

Newly-constructed covered multifamily dwellings as defined in this chapter, include, but are not limited to, the following:

- 1. Apartment buildings with 3 or more dwelling units including timeshare apartments not considered a place of public accommodation or transient lodging as defined in Health and Safety Code Section 19955 (a), and Chapter 2 of the California Building Code.*
- 2. Condominiums with 4 or more dwelling units including timeshare condominiums not considered a place of public accommodation or transient lodging as defined in Health and Safety Code Section 19955 (a), and Chapter 2 of the California Building Code.*
- 3. Lodging houses, as defined in Chapter 2 of the California Building Code, used as a residence with more than 3 but not more than 5 guest rooms.*
- 4. Congregate residences, as defined in Chapter 2 of the California Building Code, with 3 or more sleeping units.*
- 5. Dwellings with 3 or more efficiency units, as defined in Chapter 2 of this code, or Section 17958.1 of the California Health and Safety Code.*
- 6. Shelters for homeless persons, not otherwise subject to the disabled access provisions of the Division of the State Architect-Access Compliance (DSA-AC).*
- 7. Dormitories, as defined in Chapter 2 of this code, with 3 or more guest rooms as defined in Chapter 2 of the California Building Code.*
- 8. Timeshare dwellings with 3 or more units, not considered a place of public accommodations or transient lodging as defined in Health and Safety Code Section 19955 (a), and Chapter 2 of the California Building Code.*
- 9. Other Group R occupancies in covered multifamily dwellings which are regulated by the Office of the State Fire Marshal. See Section 1.11.*

SECTION 1104A COVERED MULTIFAMILY DWELLINGS

1104A.1 General. All ground-floor dwelling units in nonelevator buildings shall be adaptable and on an accessible route, unless an accessible route is not required as determined by site impracticality provisions in Section 1150A. For buildings with elevators, see Section 1106A.

Multistory dwelling units shall comply with Section 1102A.3.

1104A.2 Ground floors above grade. Where the first floor containing dwelling units in a building is above grade, all units on that floor shall be served by an accessible route. This floor will be considered a ground floor and all dwelling units are considered covered multifamily dwelling units.

SECTION 1101A APPLICATION

1101A.1 Scope. The application and authority of this chapter are identified and referenced in Sections 1.8.2.1.2 and 1102A for the Department of Housing and Community Development. Applicable sections are identified in the Matrix Adoption Tables of this code under the abbreviation HCD 1-AC. The provisions of this chapter shall apply to the following:

- 1. All newly-constructed covered multifamily dwellings.*
- 2. New common use areas serving existing covered multifamily dwellings.*
- 3. Additions to existing buildings, where the addition alone meets the definition of a covered multifamily dwelling.*
- 4. New common-use areas serving new covered multifamily dwellings.*
- 5. Where any portion of a building's exterior is preserved, but the interior of the building is removed, including all structural portions of floors and ceilings, the building is considered a new building for determining the application of this chapter.*

Chapter 11A generally does not apply to public accommodations such as hotels and motels, and public housing. Public use areas, public accommodations, and public housing as defined in Chapter 2 of this code are subject to provisions of the Division of the State Architect (DSA-AC) in Chapter 11B, and are referenced in Section 1.9.1.

1102A.2 Existing buildings. The building standards contained in this chapter do not apply to the alteration, repair, rehabilitation or maintenance of multifamily dwellings constructed for first occupancy prior to March 13, 1991.

Covered multifamily dwellings shall be maintained in compliance with the accessibility standards in effect at the time of construction. Apartments constructed prior to March 13, 1991 shall be maintained in compliance with the accessibility standards in effect at the time of construction.

Additions shall be subject to the requirements of this chapter, provided the addition, when considered alone, meets the definition of a covered multifamily dwelling, as defined in Chapter 2. New common use spaces serving existing covered multifamily dwellings shall be subject to the requirements of this chapter.

Note: For all existing public use areas, public accommodations, and public housing, see Chapter 11B for provisions of the Division of the State Architect-Access Compliance (DSA-AC).

SECTION 1128A COVERED DWELLING UNITS

1128A.1 General. Covered multifamily dwelling units shall be adaptable and accessible into and throughout the dwelling unit as provided in this division.

Note: See Sections 1101A "Application" and 1102A "Building Accessibility" for dwelling units required to comply with this division.

1102A.3 Multistory dwellings.

1102A.3.1 Multistory apartment or condominium dwellings in buildings with no elevator. This section shall apply to multistory dwelling units on the ground floor of buildings without elevators for which an application for a construction permit is submitted on or after July 1, 2005.

Exception: Carriage units as defined in Chapter 2 and regulated only by the Department of Housing and Community Development as referenced in Section 1.8.2.1.2.

At least 10 percent but not less than one of the multistory dwellings in apartment buildings with 3 or more dwelling units and/or condominiums with 4 or more dwelling units shall comply with the following:

- 1. The primary entry to the dwelling unit shall be on an accessible route unless exempted by site impracticality tests in Section 1150A.*
- 2. At least one powder room or bathroom shall be located on the primary entry level, served by an accessible route and shall comply with the provisions in Division IV.*
- 3. All rooms or spaces located on the primary entry level shall be served by an accessible route and shall comply with the provisions in Division IV. Rooms and spaces located on the primary entry level and subject to this chapter may include but are not limited to kitchens, powder rooms, bathrooms, living rooms, bedrooms or hallways.*
- 4. Common use areas covered by this section shall be accessible as required by this chapter. Public use areas as defined in Chapter 2 of this code are sub-*

ject to provisions of the Division of the State Architect (DSA-AC) and are referenced in Section 1.9.1.1.

The minimum number of multifamily dwelling units which must comply with this section shall be calculated using the total number of all multistory dwelling units in buildings on a site which are subject to this section. Any fraction thereof shall be rounded to the next highest whole number.

1102A.3.2 Multistory dwelling units in buildings with one or more elevators. Multistory dwelling units contained in buildings with elevators shall comply with this section. For multistory dwelling units in buildings with elevators, the story of the unit that is served by the building elevator is considered a ground floor and the primary entry floor to the unit and shall comply with the following:

- 1. At least 1 powder room or bathroom shall be located on the primary entry level.*
- 2. At least 1 kitchen shall be located on the primary entry level.*
- 3. All rooms or spaces located on the primary entry level shall be served by an accessible route and shall comply with Division IV.*

SECTION 1104A COVERED MULTIFAMILY DWELLINGS

1104A.1 General. All ground-floor dwelling units in nonelevator buildings shall be adaptable and on an accessible route, unless an accessible route is not required as determined by site impracticality provisions in Section 1150A. For buildings with elevators, see Section 1106A.

Multistory dwelling units shall comply with Section 1102A.3.

1104A.2 Ground floors above grade. Where the first floor containing dwelling units in a building is above grade, all units on that floor shall be served by an accessible route. This floor will be considered a ground floor and all dwelling units are considered covered multifamily dwelling units.

Exception: Carriage units as defined in Chapter 2 and regulated only by the Department of Housing and Community Development as referenced in Section 1.8.2.1.2.

Multistory dwelling units shall comply with Section 1102A.3.

SECTION 1109A PARKING FACILITIES

1109A.1 Accessible parking required. Each parking facility provided for covered multifamily dwellings and facilities (e.g., swimming pools, club houses, recreation areas and laundry rooms) that serve covered multifamily dwellings shall provide accessible parking as required by this section.

1109A.2 Parking facilities. Parking facilities shall include, but not be limited to, the following:

- 1. Garages*
- 2. Private garages*
- 3. Carports*
- 4. Off-street parking (parking lots/spaces)*

1109A.2.1 Private garages. Private garages accessory to covered multifamily dwelling units, shall be accessible as required in Section 1109A. Private garages include individual garages and multiple individual garages grouped together.

***Exception:** A private garage attached to and directly serving a single covered multifamily dwelling unit providing at least one of the following options:*

- 1. A door leading directly from the covered dwelling unit, which immediately enters the garage. The door shall comply on both sides with Sections 1132A.3 through 1132A.9.*
- 2. An accessible route of travel from the covered dwelling unit to an exterior door entering the garage. See Section 1132A.1 for requirements at both exit doors.*
- 3. An accessible route of travel from the dwelling unit's primary entry door to the vehicular entrance at the garage. See Section 1132A.1 for requirements at the primary entry door.*

1109A.3 Required accessible parking spaces. Accessible parking spaces shall be provided at a minimum rate of 2 percent of the covered multifamily dwelling units. At least one space of each type of parking facility shall be made accessible even if the total number exceeds 2 percent.

1109A.4 Assigned accessible parking spaces. When assigned parking spaces are provided for a resident or a group of residents, at least 2 percent of the assigned parking spaces serving covered multifamily dwelling units shall be accessible in each type of parking facility. At least one space of each type of parking facility shall be made accessible even if the total number exceeds 2 percent. When assigned parking is provided, signage as required by Section 1109A.8.8 shall not be required.

1109A.5 Unassigned and visitor parking spaces. When parking is provided for covered multifamily dwellings and is not assigned to a resident or a group of residents at least 5 percent of the parking spaces shall be accessible and provide access to grade-level entrances of covered multifamily dwellings and facilities (e.g., swimming pools, club houses, recreation areas, and laundry rooms) that serve covered multifamily dwellings. Accessible parking spaces shall be provided with signage as required by Section 1109A.8.8. Such signage shall not be blocked from view by a vehicle parked in the space.

1109A.6 Requests for accessible parking spaces. When assigned parking is provided, designated accessible parking for the dwelling unit shall be provided on request of residents with disabilities on the same terms and with the full range of choices (e.g., off-street parking, carport or garage) that are available for other residents.

1109A.7 Location of accessible parking spaces. The location of accessible parking spaces shall comply with the following:

- 1. Accessible parking spaces shall be located on the shortest possible accessible route to an accessible building, or covered multifamily dwelling unit entrance. All van accessible spaces may be grouped on one level of a multilevel parking facility.*
- 2. When parking facilities are located adjacent to a building with multiple accessible entrances, accessible parking spaces shall be dispersed and located near the accessible building entrances.*
- 3. When practical, the accessible route shall not cross lanes for vehicular traffic. When crossing vehicle traffic lanes is necessary, the accessible route shall be designated and marked as a crosswalk.*
- 4. Parking facilities that do not serve a particular building shall have accessible parking spaces located on the shortest possible accessible route to an accessible pedestrian entrance of the parking facility.*
- 5. Accessible parking spaces shall be located so that persons with disabilities are not compelled to wheel or walk behind parked cars other than their own.*

Exception: When the enforcement agency determines that compliance with this section or providing equivalent facilitation would create an unreasonable hardship, parking spaces may be provided which would require a person with physical disabilities to wheel or walk behind other than accessible parking spaces.

1109A.8.1 Vertical clearances. All entrances, exits and vehicular passageways to and from required accessible parking spaces within parking facilities, shall have a minimum vertical clearance of 8 feet 2 inches (2489 mm) from the floor to the lowest projection of the ceiling. Reflective warning signs complying with Section 1143A for character height shall be installed at transitions from the 8 feet 2 inch ceiling to lower ceiling heights in vehicular passageways in the same parking level.

1109A.8.2 Arrangement of parking spaces. Parking spaces shall be arranged to comply with the following:

1. In each parking area, a bumper or curb shall be provided and located to prevent encroachment of cars over the required width of walkways.
2. Ramps, including curb ramps, shall not encroach into any accessible parking space or the adjacent loading and unloading access aisle.

1109A.8.3 Slope of accessible parking spaces and access aisles. Surface slopes of accessible parking spaces and access aisles shall be the minimum possible and shall not exceed $\frac{1}{4}$ inch (6.35 mm) per foot (2.083-percent gradient) in any direction.

1109A.8.4 Accessible parking space size. Accessible parking spaces shall comply with Sections 1109A.8.5 and 1109A.8.6.

1109A.8.5 Accessible single parking space. Where accessible single spaces are provided, they shall be constructed in accordance with the following:

1. Single spaces shall be 14 feet (4267 mm) wide minimum, and shall provide a 9-foot (2743 mm) wide parking area and a 5-foot (1524 mm) wide loading and unloading access aisle. Access aisles shall be permitted to be located on either side of the vehicle, and shall extend the full required length of the parking spaces they serve.
2. When more than one space is provided, two 9-foot (2743 mm) wide parking spaces may be lined on each side of a 5-foot (1524 mm) wide loading and unloading access aisle.
3. The minimum length of each parking space shall be 18 feet (5486 mm).

4. *The loading and unloading access aisle shall be marked by a border painted blue. Within the blue border, hatched lines a maximum of 36 inches (914 mm) on center shall be painted a color contrasting with the parking surface, preferably blue or white. The words "NO PARKING" shall be painted on the ground within each 5-foot (1524 mm) wide loading and unloading access aisle. This notice shall be painted in white letters no less than 12 inches (305 mm) high and located so that it is visible from the adjacent vehicular way.*

Note: See Figures 11A-2A, 11A-2B and 11A-2C.

1109A.8.6 Van accessible parking space. *One in every eight accessible spaces, but not less than one, shall be van*

accessible and shall be constructed in accordance with the following:

1. *Each van-accessible parking space shall be 17 feet (5181 mm) wide minimum, and shall provide either of the following:*
 - 1.1. *A 12-foot (3658 mm) wide minimum parking area and a 5-foot (1524 mm) wide minimum loading and unloading access aisle.*
 - 1.2. *A 9-foot (2743 mm) wide minimum parking area and an 8-foot (2438 mm) wide minimum loading and unloading access aisle.*

Access aisles shall be located on the passenger side of the vehicle with the vehicle parked in the forward position, and shall extend the full required length of the parking spaces they serve.

2. *The minimum length of each space shall be 18 feet (5486 mm).*
3. *Each space shall be designated "van accessible" as required by Section 1109A.8.8.*
4. *All van accessible spaces may be grouped on one level of a multilevel parking facility.*
5. *The loading and unloading access aisle shall be marked by a border painted blue. Within the blue border, hatched lines a maximum of 36 inches (914 mm) on center shall be painted a color contrasting with the parking surface, preferably blue or white. The words "NO PARKING" shall be painted on the ground within each loading and unloading access aisle. This notice shall be painted in white letters no less than 12 inches (305 mm) high and located so that it is visible from the adjacent vehicular way.*

Note: See Figures 11A-2A, 11A-2B and 11A-2C.

1109A.8.7 Adjacent parking. *Parking spaces adjacent to accessible parking spaces shall not be considered as loading and unloading access aisles.*

1109A.8.8 Identification. *Each accessible parking space shall be identified with signage and surface marking in accordance with Sections 1109A.8.8.1 and 1109A.8.8.2.*

1109A.8.8.1 Parking signage. *Each accessible parking space reserved for persons with disabilities shall be identified by a reflective sign consisting of the "International Symbol of Accessibility" complying with Section 1143A.8. The sign shall not be smaller than 70 square inches (4516 mm²) in area, and shall be posted 60 inches minimum above the finish floor or ground surface, measured to the bottom of the sign. Signs located on accessible routes shall be posted at a minimum height of 80 inches (2032 mm) above the finish floor or ground surface of the accessible route, measured to the bottom of the sign.*

Signs identifying accessible parking spaces shall be visible from each parking space they serve, and shall be permanently posted immediately adjacent to the parking space or within the projected parking space width at the head end of the parking space. Signs may also be permanently posted on a wall at the interior end of the parking space.

Van accessible spaces shall comply with Section 1109A.8.6 and shall have an additional sign or additional language stating "Van Accessible" below the symbol of accessibility.

An additional sign shall also be posted in a conspicuous place at each entrance to off-street parking facilities or immediately adjacent to and visible from each accessible stall or space. The sign shall not be less than 17 inches (432 mm) by 22 inches (559 mm) in size with lettering not less than 1 inch (25.4 mm) in height, and shall clearly and conspicuously state the following:

"Unauthorized vehicles parked in designated accessible spaces not displaying distinguishing placards or special license plates issued for persons with disabilities will be towed away at the owner's expense. Towed vehicles may be reclaimed at _____ or by telephoning _____."

Blank spaces are to be filled in with appropriate information as a permanent part of the sign.

1109A.8.8.2 Parking space marking. *In addition to the signage requirements, each accessible parking space shall have a surface identification complying with either of the following:*

1. *The parking space shall be outlined or painted blue, and shall be marked with the “International Symbol of Accessibility” in white or a suitable contrasting color. The “International Symbol of Accessibility” shall be 36 inches (914 mm) wide by 36 inches (914 mm) high minimum, with the centerline 6 inches (152 mm) maximum from the centerline of the parking space, its sides parallel to the length of the parking space, and its lower side aligned with the end of the parking space.*
2. *The parking space shall be marked with the “International Symbol of Accessibility”, in white on a blue background, 36 inches (914 mm) wide by 36 inches (914 mm) high minimum in size. The centerline of the “International Symbol of Accessibility” shall be 6 inches (152 mm) maximum from the centerline of the parking space, its sides shall be parallel to the length of the parking space, and its lower side shall be aligned with the end of the parking space length.*

Note: See Figures 11A-2A, 11A-2B and 11A-2C.

SECTION 1113A

WALKS AND SIDEWALKS ON ACCESSIBLE ROUTES

1113A.1 Width and continuous surface. Walks and sidewalks subject to this chapter shall have a continuous common surface, not interrupted by steps or by abrupt changes in level exceeding $\frac{1}{2}$ inch (12.7 mm). (See Section 1111A).

Walking surfaces shall be stable, firm, and slip resistant, and shall comply with Section 1110A.3.

1113A.1.1 Width. Walks and sidewalks shall be a minimum of 48 inches (1219 mm) in width, except that walks serving an individual dwelling unit in covered multifamily buildings may be reduced to 36 inches (914 mm) in clear width except at doors.

1113A.1.2 Surface cross slopes. Surface cross slopes shall not exceed 1 unit vertical in 48 units horizontal (2.083-percent slope).

1113A.2 Walks with continuous gradients. All walks on an accessible route with continuous gradients shall have level areas at least 60 inches (1524 mm) in length at intervals of at least every 400 feet (122 m).

1113A.3 Five percent gradient. When the slope in the direction of travel of any walk on an accessible route exceeds 1 unit vertical in 20 units horizontal (5-percent slope), it shall comply with the ramp provisions of Section 1114A.

1113A.4 Level areas. Walks on an accessible route shall be provided with a level area at each side of a door or gate. Level areas shall comply with the applicable requirements for maneuvering clearances in Section 1126A.3.

1113A.5 Gratings. Walks, sidewalks and pedestrian ways on an accessible route shall be free of gratings whenever possible. Gratings located in the surface of any of these areas, grid openings in gratings shall be limited to $\frac{1}{2}$ inch (12.7 mm) in the direction of traffic. Elongated openings in gratings shall be placed so that the long dimension is perpendicular to the dominant direction of traffic.

**SECTION 1114A
EXTERIOR RAMPS AND LANDINGS
ON ACCESSIBLE ROUTES**

1114A.1 Width. *The clear width of ramps shall be consistent with the requirements in Chapter 10 of this code, but in no case shall be less than 48 inches (1219 mm)*

Handrails may project into the required clear width of the ramp at each side 3¹/₂ inches (89 mm) maximum at the hand-rail height. Curbs, wheel guides and/or appurtenances shall not project into the required clear width of ramps.

Exception: The clear width of ramps serving accessible entrances to covered multifamily dwellings with an occupant load of 10 or less may be 36 inches (914 mm) minimum between handrails.

Note: See Section 1114A.6.2.4 for handrail projections.

1114A.2 Slope. *The maximum slope of ramps on an accessible route shall be no greater than 1 unit vertical in 12 units horizontal (8.33-percent slope). Transitions from ramps to walks, gutters or streets shall be flush and free of abrupt changes.*

Exception: Ramps serving decks, patios or balconies as specified in Section 1132A.4.

1114A.2.1 Cross slope. *The cross slope of ramp surfaces shall be no greater than 1 unit vertical in 48 units horizontal (2.083-percent slope).*

1114A.3 Outdoor ramps. *Outdoor ramps, ramp landings and their approaches shall be designed so that water will not accumulate on the walking surface.*

1114A.4 Landings. *Ramp landings shall be level and comply with this section.*

1114A.4.1 Location of landings. *Landings shall be provided at the top and bottom of each ramp. Intermediate landings shall be provided at intervals not exceeding 30 inches (762 mm) of vertical rise and at each change of direction. Landings are not considered in determining the maximum horizontal distance of each ramp.*

1114A.6 Ramp handrails.

1114A.6.1 Where required. Handrails shall be provided at each side of ramps when the slope exceeds 1 unit vertical in 20 units horizontal (5-percent slope).

Exceptions:

1. Curb ramps.
2. Ramps that serve an individual dwelling unit may have one handrail, except that ramps open on one or both sides shall have handrails provided on the open side or sides.
3. Ramps at exterior door landings with less than 6 inches (152 mm) rise or less than 72 inches (1829 mm) in length.

1114A.6.2 Handrail configuration.

1114A.6.2.1 Handrail heights. The top of handrails shall be 34 to 38 inches (864 to 965 mm) above the ramp surface.

1114A.6.2.2 Handrail continuity. Handrails on all ramps shall be continuous within the full length of each ramp run. Inside handrails on switchback or dogleg ramps shall be continuous between ramp runs.

1114A.6.2.3 Handrail extensions. Handrails shall extend a minimum of 12 inches (305 mm) horizontally above landings, beyond the top and bottom of the ramp runs. Extensions shall return to a wall, guard, or the walking surface, or shall be continuous to the handrail of an adjacent ramp run. Handrail extensions shall be in the same direction as the ramp runs. (See Figure 11A-5A.)

1116A.2 Headroom clearance. Walks, pedestrian ways, and other circulation spaces, which are part of the required egress system, shall have a minimum clear headroom as required in Section 1003.2. Other walks, pedestrian ways, and circulation spaces shall have a minimum clear headroom of 80 inches (2032 mm). If the vertical clearance of an area adjoining an accessible route is reduced to less than 80 inches (2032 mm), a guardrail or other barrier having its leading edge at or below 27 inches (686 mm) above the finished floor shall be provided.

Exception: Doorways and archways less than 24 inches (610 mm) in depth may have a minimum clear headroom of 80 inches (2032 mm). (See Section 1126A for door requirements.)

1116A.3 Overhanging obstructions. Any obstruction that overhangs a pedestrian way shall be a minimum of 80 inches (2032 mm) above the walking surface as measured from the bottom of the obstruction. (See Figure 11A-1B.) Where a guy support is used parallel to a path of travel, including, but not limited to, sidewalks, a guy brace, sidewalk guy or similar device shall be used to prevent an overhanging obstruction. (See Section 1116A.2 for required headroom clearance.)

Exception: Door closers and door stops shall be permitted to be 78 inches (1981 mm) minimum above the finish floor or ground.

1116A.4 Free-standing signs. Wherever signs mounted on posts or pylons protrude from the post or pylons and the bottom edge of the sign is less than 80 inches (2032 mm) above the finished floor or ground level, the edges of such signs shall be rounded or eased and the corners shall have a minimum radius of 0.125 inches (see Section 1116A.2 for required headroom clearance).

**SECTION 1126A
DOORS, GATES AND WINDOWS**

1126A.1 Width and height of doors and gates. Doorways which provide access to common use areas or covered multi-family dwellings shall comply with the following:

1. Permit the installation of a door or gate not less than 36 inches (914 mm) in width, not less than 80 inches (2032 mm) in height, and provide a clear opening of not less than 32 inches (813 mm), measured with the door positioned at an angle of 90 degrees from its closed position.
2. Doors or gates shall be capable of opening at least 90 degrees.
3. A pair of doors or gates, manual or automatic, shall have at least one leaf which provides a clear width of not less than 32 inches (813 mm), measured with the door or gate positioned at an angle of 90 degrees from its closed position.
4. The width of any component in the egress system shall not be less than the minimum width required by Section 1005.
5. Revolving doors or gates shall not be used as required entrances for persons with disabilities, and shall not be part of an accessible route.

1126A.2 Level floor or landing. The floor or landing on each side of an exit door or gate shall be level. (See Chapter 10.)

1126A.2.1 Thresholds and changes in elevation. The floor or landing shall not be more than $\frac{1}{2}$ inch (12.7 mm) lower than the top of the threshold of the doorway. (See Figure 11A-8I.)

Changes in level between $\frac{1}{4}$ inch (6.35 mm) and $\frac{1}{2}$ inch (12.7 mm) shall be beveled with a slope no greater than 1 unit vertical in 2 units horizontal (50-percent slope). Changes in level greater than $\frac{1}{2}$ inch (12.7 mm) shall be accomplished by means of a ramp. (See Section 1122A.)

1124A.11 Platform (wheelchair) lifts.

1124A.11.1 General. Platform (wheelchair) lifts may be provided between levels, in lieu of passenger elevators, when the vertical distance between landings, as well as the structural design and safeguards are as allowed by ASME A18.1 (Safety Standard for Platform Lifts and Stairway Chair Lifts), California Code of Regulations, Title 8 (Elevator Safety Orders), and any applicable safety regulations of other administrative authorities having jurisdiction.

If lifts are provided, they shall be designed and constructed to facilitate unassisted entry, operation and exit from the lift, and shall comply with restrictions and enhancements of this section in conjunction with Title 8 of the California Code of Regulations.

SECTION 1127A COMMON USE FACILITIES

Note: For public use facilities, see Chapter 11B of this code.

1127A.1 General. When provided, common use areas and facilities in covered multifamily housing developments shall be accessible to persons with disabilities. Common use facilities include, but are not limited to, lobbies, toilet and bathing facilities, laundry facilities, community rooms, clubhouses, health and fitness facilities, game rooms and portions of common use tenant storage. All entrances, doors, fixtures and controls shall be on an accessible route. Facilities and fixtures required to be accessible shall comply with the following provisions:

- 1. **Doors.** Doors to accessible bathrooms shall comply with Section 1126A. Doors shall not swing into the floor space required for any fixture.*
- 2. **Clear floor space.** All fixtures and controls shall be on an accessible route. Clear floor spaces at fixtures and controls, the accessible route and the turning space may overlap. This clear space shall comply with Sections 1138A.1.4 and 1138A.3.*
- 3. **Water closets.** Where a toilet stall is provided, it shall comply with Section 1127A.2.1 or 1127A.2.2, and its water closet shall comply with Section 1127A.2.3.*
- 4. **Lavatory and mirrors.** Where a lavatory and/or mirror is provided, it shall comply with Sections 1127A.3 and/or 1127A.8.3.*
- 5. **Controls and dispensers.** Where controls, dispensers, receptacles or other types of equipment are provided, at least one of each shall be on an accessible route and shall comply with Sections 1127A.8 and 1138A.3.*
- 6. **Bathing and shower facilities.** Where bathtubs or showers are provided, at least one fixture of each type provided shall be accessible per room. For bathtubs, see Section 1127A.5.2. For shower compartments, see Section 1127A.5.3.*
- 7. **Toilet facilities.** Toilet facilities shall comply with Section 1127A.2.*
- 8. **Laundry facilities.** Laundry facilities shall comply with Section 1127A.10.*
- 9. **Storage facilities.** Storage facilities shall comply with Section 1127A.11.*
- 10. **Fixed or built-in seating, tables and counters.** Fixed or built-in seating, tables and counters shall comply with Section 1127A.12.*

1127A.9 Space allowances and reach ranges in common use areas.

Space allowances and reach ranges in common use areas shall comply with Section 1138A.

1127A.10 Common accessible laundry rooms.

1127A.10.1 General. Where common use laundry rooms are provided, at least one of each type of appliance provided in each laundry area shall be accessible, shall be on an accessible route and shall comply with this section. Such appliances include clothes washing machines, dryers, soap dispensers and any related features such as wash sinks, tables and storage areas.

Where laundry rooms are provided on floors of an elevator building, each laundry room shall be accessible. Where there is one laundry room on a ground floor in each building, each laundry room shall be accessible. Where there is a laundry room on the ground floor of a building and another located in the basement, it is acceptable to have only the ground floor laundry room accessible.

1127A.10.2 Clear floor space. There shall be a minimum clear space 30 inches perpendicular by 48 inches parallel (762 mm by 1219 mm) in front of clothes washers and dryers required to be accessible. There shall be a minimum clear space 30 inches by 48 inches (762 mm by 1219 mm) provided for at least one of each type of fixture or appliance provided in the laundry room (e.g., soap dispensers, wash sinks, tables, storage areas).

1127A.10.3 Controls and operating mechanisms. Clothes washers and dryers including stacked clothes washers and dryers required to be accessible shall have controls and operating mechanisms (including doors, coin slots, lint screens, detergent and bleach compartments) within the reach range of a seated user. Controls and operating mechanisms shall be located no higher than 48 inches (1219 mm), and no lower than 15 inches (381 mm), above the finished floor measured to the center of the grip. If the reach is over an obstruction (for example, washer or dryer), operating mechanisms shall be located within the reach ranges specified in Section 1138A.3. Controls and

operating mechanisms that do not satisfy these specifications are acceptable, provided that comparable mechanisms, controls or outlets that perform the same functions are provided within the same area and are accessible.

Controls and operating mechanisms shall be operable with one hand and not require tight grasping, pinching or twisting of the wrist. The force required to activate controls and operating mechanisms shall be no greater than 5 pounds (22.2 N).

1127A.10.4 Washing machines and clothes dryers. Washing machines and clothes dryers in accessible common use laundry rooms shall be front loading.

The bottom of the opening to the laundry compartment shall be located 15 inches (381 mm) minimum and 36 inches (914 mm) maximum above the finish floor.

**SECTION 1128A
COVERED DWELLING UNITS**

1128A.1 General. Covered multifamily dwelling units shall be adaptable and accessible into and throughout the dwelling unit as provided in this division.

Note: See Sections 1101A "Application" and 1102A "Building Accessibility" for dwelling units required to comply with this division.

**SECTION 1129A
Reserved**

**SECTION 1130A
ACCESSIBLE ROUTE WITHIN COVERED
MULTIFAMILY DWELLING UNITS**

1130A.1 General. An accessible route shall be provided through all rooms and spaces of the dwelling unit. The accessible route shall pass through the primary entry door, and shall connect with all additional exterior doors, required clear floor spaces at kitchen appliances and bathroom fixtures. For the purpose of this section, "accessible routes" may include hallways, corridors and ramps.

Exception: An accessible route is not required from the interior of the unit into a basement or garage, except as provided in Section 1105A.1.

1130A.2 Width. The accessible route into and throughout covered multifamily dwelling units shall be at least 36 inches (914 mm) wide.

SECTION 1132A DOORS

1132A.1 Primary entry doors and required exit doors. *The width and height of primary entry doors and all required exit doors shall comply with Section 1126A.1. The requirements of Sections 1126A.3 shall apply to maneuvering clearances at the side of the door exposed to common or public use spaces (e.g., entry or exit doors which open from the covered multi-family dwelling unit into a corridor, hallway or lobby, or directly to the outside).*

1132A.2 Interior doors and secondary exterior doors. *Except as allowed by Section 1109A.2, interior doors intended for user passage and secondary exterior doors shall comply with this section. The provisions of this section shall apply to the dwelling unit side of doors leading from the interior of the dwelling unit to an unfinished basement or an attached garage.*

1132A.3 Width and height of interior doors and secondary exterior doors. *Doors shall comply with the following:*

- 1. Doors shall not be less than 6 feet 8 inches (2032 mm) in height.*
- 2. Swinging doors shall provide a net clear opening width of not less than 32 inches (813 mm), measured with the door or doors positioned at an angle of 90 degrees from the closed position.*
- 3. Swinging doors shall be capable of opening at least 90 degrees.*
- 4. A nominal 32-inch (813 mm) clear opening provided by a standard 6-foot wide (1829 mm) sliding patio door assembly is acceptable.*
- 5. A pair of doors, manual or automatic, must have at least one leaf which provides a clear width of not less than 32 inches (813 mm), measured with the door positioned at an angle of 90 degrees from its closed position.*
- 6. The width of any component in the means of egress system shall not be less than the minimum width required by Section 1005.*

1132A.4 Level floor or landing. *See also Chapter 10. The floor or landing on each side of a door shall be level. Primary entry doors, required exit doors or secondary exterior doors with changes in height between the interior surface or floor level and the exterior surface or floor level shall comply with the following:*

- 1. Exterior landings of impervious construction (e.g., concrete, brick, flagstone) serving primary entry doors and required exit doors are limited to not more than $\frac{1}{2}$ inch (12.7 mm) of change in height between floor surfaces. Changes in level shall comply with Section 1131A.*

2. *Exterior landings of pervious construction (e.g., wood decking with spaces) shall be the same level as the interior landing, except that secondary exterior doors may have no more than 1/2 inch (12.7 mm) of change in height between floor surfaces. Changes in level shall comply with Section 1131A.*

3. *Secondary exterior doors onto decks, patios or balcony surfaces constructed of impervious materials (e.g., concrete, brick, flagstone) may have a maximum change in height from the interior landing of 4 inches (101.6 mm). Changes in height greater than 1/2 inch (12.7 mm) shall be accomplished by means of a ramp complying with Section 1114A or by means of a platform constructed to the level of the floor as illustrated in Figure 11A-8J.*

4. *Secondary exterior doors onto decks, patios or balcony surfaces constructed of impervious materials (e.g., concrete, brick, flagstone) may have a maximum change in height from the interior landing of 1 inch (25.4 mm), provided a ramp with a maximum slope of 1:8 is permanently installed. (See Figure 11A-8K.)*

5. *In buildings containing covered multifamily dwelling units, the floor or landing immediately outside the entry may be sloped up to 1/4 inch (6.35 mm) per foot (12 inches) (305 mm), in a direction away from the primary entrance of the dwelling unit for drainage.*

1132A.4.1 Thresholds. *Thresholds at the primary entry and required exit doors shall be no higher than 1/2 inch (12.7 mm). Thresholds at secondary exterior doors, including sliding door tracks, shall be no higher than 3/4 inch (19.05 mm). Changes in height at interior door thresholds (e.g., floor material changes at door thresholds) shall not exceed 1/2 inch (12.7 mm). Thresholds shall comply with the following:*

1. *Thresholds with a change in height of not more than 1/4 inch (6.35 mm) may be vertical.*
2. *Thresholds with a change in height between 1/4 inch (6.35 mm) and 3/4 inch (19.05 mm) shall be beveled with a slope no greater than 1 unit vertical in 2 units horizontal (50-percent slope).*

1132A.5 Maneuvering clearances at doors.

1132A.5.1 General. *The floor or landing on the dwelling unit side of the primary entry door and any required exit door shall have a minimum length of not less than 44 inches (1118 mm). Section 1126A.3 shall apply to maneuvering clearances at the side of the door exposed to common or public use spaces.*

Maneuvering clearances at interior doors shall provide a minimum length on both sides of the door of at least 42 inches (1067 mm) measured at a right angle to the plane of the door in its closed position.

Exception: *A 39-inch (991 mm) length is acceptable at interior doors when a minimum clear opening width of 34 inches (864 mm) is provided.*

1132A.5.2 Strike edge maneuvering space at doors. *The width of the level area on the side to which the door swings shall extend 18 inches (457 mm) past the strike edge for all doors. The width of the level area at the exterior side of the primary entry door and any required exit doors shall comply with Section 1126A.*

Notes:

1. See Section 1134A for bathrooms that are required to be accessible.
2. Twenty-four inches (610 mm) is preferred for strike edge clearance.

1132A.10 Door signal devices. *Every primary entrance to a covered multifamily dwelling unit shall be provided with a door buzzer, bell, chime or equivalent. The activating mechanism shall be mounted a maximum of 48 inches (1219 mm) above the floor and connected to permanent wiring.*

SECTION 1133A KITCHENS

1133A.1 General. *Kitchens shall be on an accessible route and shall comply with this section. (See Figure 11A-10A.)*

1133A.2 Clear floor space. *Clear floor space at kitchens shall comply with the following:*

1. A clear floor space at least 30 inches (762 mm) by 48 inches (1219 mm) that allows a parallel approach by a person in a wheelchair shall be provided at the range or cooktop.
2. A clear floor space at least 30 inches (762 mm) by 48 inches (1219 mm) that allows either a parallel or forward approach shall be provided at the kitchen sink and all other fixtures or appliances including the oven, dishwasher, refrigerator/freezer and trash compactor.
3. A clear floor space at least 30 inches (762 mm) by 48 inches (1219 mm) that allows either a parallel or a forward approach shall be provided at the work surface required by Section 1133A.4.
4. The centerline of the 30-inch (762 mm) by 48-inch (1219 mm) clear floor space provided for parallel or forward approach shall be aligned with the centerline of the work space, appliance or fixture.

1133A.2.1 Clear width. *Kitchens shall have a minimum clear width measured between any cabinet, countertop or the face of any appliance (excluding handles and controls) that projects into the kitchen and the opposing cabinet, countertop, appliance or wall as follows:*

1. *U-shaped kitchens, designed with parallel approach at a range or cooktop located at the base of the U, shall have a minimum clear width of at least 60 inches (1524 mm). (See Figure 11A-10A.)*
2. *U-shaped kitchens, designed with a cooktop or sink located at the base of the U, which provides a knee and toe space in accordance with Section 1133A.7 to allow for a forward approach, shall have a clear width of at least 48 inches (1219 mm). (See Figure 11A-10A.)*
3. *All other kitchen designs shall provide a minimum clear width of at least 48 inches (1219 mm). (See Figure 11A-10A.)*

1133A.3 Removable base cabinets. *Sinks and work surfaces required by Section 1133A.4 (see Item 1 and Item 2) shall be provided with knee and toe space complying with Section 1133A.7. Base cabinets (including toeboard and shelving) directly under kitchen sinks and work surfaces shall be removable without the use of specialized tools or specialized knowledge in order to provide knee and toe space. The finish floor beneath kitchen sinks and work surfaces shall be extended to the wall.*

1133A.4 Countertops. *Kitchen countertops shall comply with this section and shall be provided with the following:*

1. *A minimum linear length of 30 inches (762 mm) of countertop shall be provided for the kitchen sink installation.*
2. *A minimum linear length of 30 inches (762 mm) of countertop shall be provided for a work surface.*
3. *Sinks and work surfaces may be a single integral unit a minimum of 60 inches (1524 mm) in length, or be separate components.*

Exception: *Two 15-inch (381 mm) wide minimum breadboards may be provided in lieu of the required 30 inches (762 mm) of countertop work surface.*

1133A.7 Knee and toe space. *Knee and toe space, when required by Section 1133A, shall comply with Section 1138A.2 and the following:*

1. *The knee and toe space shall be clear and unobstructed, or removable base cabinets in compliance with Section 1133A.3 shall be provided.*
2. *The knee and toe space shall be 30 inches (762 mm) wide minimum, centered on the sink, countertop or appliance.*
3. *A clear floor space shall not extend into the knee and toe space more than 19 inches (483 mm).*

**SECTION 1134A
BATHING AND TOILET FACILITIES**

1134A.1 General. All bathrooms, bathing and toilet facilities within covered multifamily dwelling units shall comply with this section.

1134A.2 Number of complying bathrooms. Bathrooms shall be designed to comply with one of the following options:

Option 1. All bathrooms within the dwelling unit shall be designed to comply with the following:

1. Toilet, bathing and shower facilities shall comply with Section 1134A.4.
2. Bathtubs shall comply with Section 1134A.5.
3. Showers shall comply with Section 1134A.6.
4. Water closets shall comply with Section 1134A.7.
5. Lavatories, vanities, mirrors and towel fixtures shall comply with Section 1134A.8.
6. Bathrooms shall be provided with an accessible route into and through the bathroom.
7. If a door is provided, it shall comply with the requirements of Section 1132A.5.
8. A minimum 18-inch (457 mm) clear maneuvering space shall be provided on the swing side of the door at the strike edge of the door.
9. Switches, outlets and controls shall comply with Section 1142A.
10. Reinforced walls to allow for the future installation of grab bars around the toilet, tub and shower shall comply with Sections 1134A.5 for bathtubs, 1134A.6 for showers and 1134A.7 for water closets. Grab bars shall comply with Sections 1127A.4- and 1127A.2.2, Item 4.

Option 2. Only one bathroom within the dwelling unit shall be designed to comply with the following:

1. Toilet, bathing and shower facilities shall comply with Section 1134A.4.
2. Bathtubs shall comply with Section 1134A.5.
3. Showers shall comply with Section 1134A.6.
4. Water closets shall comply with Section 1134A.7.
5. Lavatories, vanities, mirrors and towel fixtures shall comply with Section 1134A.8.
6. Where both a tub and shower are provided in the bathroom, at least one shall be made accessible. Additional requirements apply to dwelling units containing two or more bathrooms when a bathtub is provided as the accessible bathing fixture.

Where two or more bathrooms are provided within the same dwelling unit and a bathtub is installed to comply with Option 2, Item 6 in one bathroom and a shower stall is provided in a subsequent bathroom, both the bathtub selected to comply with Option 2, Item 6 and at least one shower stall within the dwelling unit shall meet all the applicable accessibility requirements provided

in Section 1134A. (See Section 1134A.5 for bathtubs, or Section 1134A.6 for showers.)

7. *When two or more lavatories are provided, at least one shall be made accessible and comply with Section 1134A.8.*
8. *Bathrooms shall be provided with an accessible route into and through the bathroom.*
9. *If a door is provided, it shall comply with the requirements of Section 1132A.5.*
10. *A minimum 18-inch (457 mm) clear maneuvering space shall be provided on the swing side of the door at the strike edge of the door.*
11. *Switches, outlets and controls shall comply with Section 1142A.*
12. *Reinforced walls to allow for the future installation of grab bars around the toilet, tub and shower shall comply with Sections 1134A.5 for bathtubs, 1134A.6 for showers and 1134A.7 for water closets. Grab bars shall comply with Sections 1127A.4 and 1127A.2.2, Item 4.*

When Option 2 is used, all additional bathrooms must comply with Items 8 through 12 above.

1134A.3 Powder rooms. *All powder rooms shall be designed to comply with Section 1134A.2, Option 2, Items 8 through 12. When the powder room is the only toilet facility located on an accessible level, it shall comply with the Option 2 items listed above, plus all additional requirements located in Sections 1134A.4, 1134A.7 and 1134A.8.*

1134A.4 Sufficient maneuvering space. *Bathing and toilet facilities required to be adaptable shall provide sufficient maneuvering space for a person using a wheelchair or other mobility aid to enter and close the door, use the fixtures, reopen the door and exit.*

Where the door swings into the bathroom or powder room, there shall be a clear maneuvering space outside the swing of the door of at least 30 inches by 48 inches (762 mm by 1219 mm) within the room. The clear maneuvering space shall allow the user to position a wheelchair or other mobility aid clear of the path of the door as it is closed and to permit use of fixtures.

Doors may swing into the required clear space at any fixture when a clear maneuvering space is provided outside the swing arc of the door so it can be closed.

Maneuvering spaces may include any knee space or toe space available below bathroom fixtures.

1134A.5 Bathtubs. *Bathtubs required to be accessible shall comply with this section.*

1. **Floor space.** *There shall be a minimum clear floor space 48 inches parallel by 30 inches perpendicular (1219 mm by 762 mm) to the side of a bathtub or bathtub-shower combination to provide for the maneuvering of a wheelchair and transfer to and from the bathing facilities. The controls shall be on the wall at the foot of the bathtub. The edge of the clear floor space shall be flush with the control wall surface. The*

area under a lavatory, located at the control end of the tub, may be included in the clear floor space provided the lavatory is 19 inches (483 mm) maximum deep, and the knee and toe space comply with Section 1134A.8. Cabinets under lavatories and toilets shall not encroach into the clear floor space.

1134A.6 Showers. Showers required to be accessible shall comply with this section.

1. **Size.** When one or more shower stalls are provided within the same dwelling units, at least one shower stall comply with one of the following requirements.
 - 1.1. The shower stall shall measure at least 42 inches wide by 48 inches deep (1067 mm by 1219 mm) with an entrance opening of at least 36 inches (914 mm); or
 - 1.2. The shower stall shall measure at least 30 inches deep by 60 inches wide (762 mm by 1524 mm) with an entrance opening of at least 60 inches (1524 mm). A water closet may project a maximum of 12 inches (305 mm) into the opening, provided that a minimum of 36 inches (914 mm) clear space is maintained between the water closet and the shower wall as illustrated in Figure 11A-9L; or
 - 1.3. Other shower stall configurations shall measure at least 36 inches deep by 60 inches wide (914 mm by 1524 mm) with an entrance opening of at least 36 inches (914 mm) when a wall is installed on the opening side.
2. **Slope.** The maximum slope of the shower floor shall be $\frac{1}{2}$ inch (12.7 mm) per foot in any direction and shall slope to a drain. The floor surfaces shall be of Carborundum or grit-faced tile or of material providing equivalent slip resistance.
3. **Floor space.** A clear maneuvering space at least 30 inches in width by 48 inches in length (762 mm by 1219 mm) shall be located outside the shower, flush and parallel to the control wall.
4. **Reinforced walls for grab bars.** Grab bar reinforcement shall be installed continuous in the walls of showers 32 inches to 38 inches (813 mm to 965 mm) above the floor. The grab bar reinforcement shall be a minimum of 6 inches (152.4 mm) nominal in height.

Glass-walled shower stalls shall provide reinforcement for installation of floor-mounted or ceiling-mounted grab bars.
5. **Thresholds.** When a threshold is used, it shall be a maximum of 2 inches (50.8 mm) in height and have a beveled or sloped angle not exceeding 1 unit vertical in 2 units horizontal (26.6 degrees from the horizontal). Thresholds $\frac{1}{2}$ inch (12.7 mm) or less in height may have a beveled or sloped angle not exceeding 1 unit vertical in 1 unit horizontal (45 degrees from the horizontal).

- 1.1. *The shower stall shall measure at least 42 inches wide by 48 inches deep (1067 mm by 1219 mm) with an entrance opening of at least 36 inches (914 mm); or*
 - 1.2. *The shower stall shall measure at least 30 inches deep by 60 inches wide (762 mm by 1524 mm) with an entrance opening of at least 60 inches (1524 mm). A water closet may project a maximum of 12 inches (305 mm) into the opening, provided that a minimum of 36 inches (914 mm) clear space is maintained between the water closet and the shower wall as illustrated in Figure 11A-9L or;*
 - 1.3. *Other shower stall configurations shall measure at least 36 inches deep by 60 inches wide (914 mm by 1524 mm) with an entrance opening of at least 36 inches (914 mm) when a wall is installed on the opening side.*
2. **Slope.** *The maximum slope of the shower floor shall be $\frac{1}{2}$ inch (12.7 mm) per foot in any direction and shall slope to a drain. The floor surfaces shall be of Carborundum or grit-faced tile or of material providing equivalent slip resistance.*
3. **Floor space.** *A clear maneuvering space at least 30 inches in width by 48 inches in length (762 mm by 1219 mm) shall be located outside the shower, flush and parallel to the control wall.*
4. **Reinforced walls for grab bars.** *Grab bar reinforcement shall be installed continuous in the walls of showers 32 inches to 38 inches (813 mm to 965 mm) above the floor. The grab bar reinforcement shall be a minimum of 6 inches (152.4 mm) nominal in height.
*Glass-walled shower stalls shall provide reinforcement for installation of floor-mounted or ceiling-mounted grab bars.**
5. **Thresholds.** *When a threshold is used, it shall be a maximum of 2 inches (50.8 mm) in height and have a beveled or sloped angle not exceeding 1 unit vertical in 2 units horizontal (26.6 degrees from the horizontal). Thresholds $\frac{1}{2}$ inch (12.7 mm) or less in height may have a beveled or sloped angle not exceeding 1 unit vertical in 1 unit horizontal (45 degrees from the horizontal).*
6. **Shower controls.** *Faucet controls and operation mechanisms shall be operable with one hand and shall not require tight grasping, pinching or twisting of the wrist. The force required to activate controls shall be no greater than 5 pounds (22.2 N). Lever operated, push-type and electronically controlled mechanisms are examples of acceptable designs.*
7. **Shower enclosures.** *Doors and panels of shower enclosures shall be substantially constructed from approved, shatter-resistant materials. Hinged shower doors shall*

open outward. Glazing used in doors and panels of shower enclosures shall be fully tempered, laminated safety glass or approved plastic. When glass is used, it shall have minimum thickness of not less than $\frac{1}{8}$ inch (3.17 mm) when fully tempered, or $\frac{1}{4}$ inch (6.35 mm) when laminated, and shall pass the test requirements of this part, Chapter 24, Glass and Glazing. Plastics used in doors and panels of shower enclosures shall be of a shatter-resistant type.

1134A.7 Water closets. Water closets in bathrooms or powder rooms required to be accessible shall comply with this section.

1. **Floor space and location.** The minimum floor space provided at a water closet shall be 48 inches (1219 mm) in clear width. The clear floor space shall extend past the front edge of the water closet at least 36 inches (914 mm). See Figure 11A-9M.

Exception: The 48-inch (1219 mm) minimum clear width may be reduced to 36 inches (914 mm) for lavatories, cabinets, wing walls or privacy walls located immediately adjacent to a water closet which extend no more than 24 inches (610 mm) in depth.

Water closets shall be located within bathrooms in a manner that permits a grab bar to be installed on at least one side of the fixture. The centerline of the water closet shall be 17 inches (432 mm) minimum to 18 inches (457 mm) maximum from a grab bar wall or partition. In locations where water closets are adjacent to non-grab bar walls, vanities, lavatories or bathtubs, the centerline of the fixture shall be a minimum of 18 inches (457 mm) from the obstacle.

2. **Reinforced walls for grab bars.** Where the water closet is not placed adjacent to a side wall capable of accommodating a grab bar, the bathroom shall have provisions for installation of floor-mounted, foldaway or similar alternative grab bars.

Where the water closet is placed adjacent to a side wall, reinforcement shall be installed on both sides or one side and the back. If reinforcement is installed at the back, it shall be installed between 32 inches (813 mm) and 38 inches (965 mm) above the floor. The grab bar reinforcement shall be a minimum of 6 inches (152.4 mm) nominal in height. The backing shall be a minimum of 40 inches (1016 mm) in length.

Reinforcement installed at the side of the water closet shall be installed 32 inches to 38 inches (813 mm to 965 mm) above the floor. The reinforcement shall be installed a maximum of 12 inches (305 mm) from the rear wall and shall extend a minimum of 26 inches (660 mm) in front of the water closet. The grab bar reinforcement shall be a minimum of 6 inches (152.4 mm) nominal in height.

3. **Seat height.** The minimum height of water closet seats shall be 15 inches (381 mm) above the floor.

4. **Water closet controls.** Water closet controls shall be mounted no more than 44 inches (1118 mm) above the floor. The force required to activate controls shall be no greater than 5 pounds (22.2 N).

1134A.8 Lavatories, vanities, mirrors and towel fixtures. Bathrooms or powder rooms required to be accessible shall have at least one accessible lavatory. Where mirrors and towel fixtures are provided, at least one of each shall be accessible.

1. **Location.** Vanities and lavatories shall be installed with the centerline of the fixture a minimum of 18 inches (457 mm) horizontally from an adjoining wall or fixture to allow for forward approach. When parallel approach is provided, lavatories shall be installed with the centerline of the fixture a minimum of 24 inches (610 mm) horizontally from an adjoining wall or fixture. The top of the fixture rim shall be a maximum of 34 inches (864 mm) above the finished floor.
2. **Floor space.** A clear maneuvering space at least 30 inches by 48 inches (762 mm by 1219 mm) shall be provided at lavatories and shall be centered on the lavatory.
3. **Cabinets.** Cabinets under lavatories are acceptable provided the bathroom has space to allow a parallel approach by a person in a wheelchair and the lavatory cabinets are designed with adaptable knee and toe space.
4. **Knee and toe space.** Knee and toe space shall be provided by one of the following:
 - 4.1. The space beneath the lavatory shall be left clear and unobstructed;
 - 4.2. Any cabinet beneath the lavatory shall be removable without the use of specialized knowledge or specialized tools; or
 - 4.3. Doors to the cabinet beneath the lavatory shall be removable or openable to provide the required unobstructed knee and toe space.

The knee and toe space shall be centered on the fixture, and shall comply with Section 1138A.2. The clear floor space required by Item 2 shall not extend into the knee and toe space more than 19 inches (483 mm). (See Figure 11A-9D.)

5. **Finished floor.** The finished floor beneath the lavatory shall be extended to the wall.
6. **Plumbing protection.** Water supply and drain pipes under lavatories shall be insulated or otherwise covered to protect against contact. There shall be no sharp or abrasive surfaces under lavatories.
7. **Lavatory faucet controls.** Faucet controls and operation mechanisms shall be operable with one hand and shall not require tight grasping, pinching or twisting of the wrist.

The force required to activate controls shall be no greater than 5 pounds (22.2 N). Lever operated, push-type and electronically controlled mechanisms are examples of acceptable designs. Self-closing valves are allowed if the faucet remains open for at least 10 seconds.

8. *Mirrors and towel fixtures. Where mirrors or towel fixtures are provided they shall be mounted with the bottom edge no higher than 40 inches (1016 mm) from the floor.*

SECTION 1135A LAUNDRY ROOMS

1135A.1 General. *If clothes washing machines and clothes dryers are provided in covered multifamily dwelling units, one of each type of appliance shall be provided. Where front-loading clothes washers are not provided, management shall provide assistive devices, on request of the occupant, to permit the use of top-loading clothes washers.*

SECTION 1137A OTHER FEATURES AND FACILITIES

1137A.1 General. *This division shall apply to features and facilities of common use areas on accessible floors or sites.*

Note: *The provisions in this division are not applicable to dwelling units, unless otherwise specified.*

SECTION 1141A ACCESSIBLE SWIMMING POOLS

1141A.1 General. *Swimming pools in common use areas shall comply with the provisions of this section and Chapter 31B.*

1141A.2 Swimming pool deck areas. *Swimming pool deck areas must be accessible, and a mechanism to assist persons with disabilities gain entry into the pool and exit from the pool shall be provided. Such a mechanism may consist of a swimming pool lift device as long as the device meets all of the following criteria:*

1. *Has a seat that meets all of the following:*
 - 1.1. *The seat must be rigid;*
 - 1.2. *The seat must be not less than 17 inches (432 mm) and not more than 19 inches (483 mm), inclusive of any cushioned surface that might be provided, above the pool deck;*
 - 1.3. *The seat must have two armrests. The armrest on the side of the seat by which access is gained shall be either removable or fold clear of the seat;*
 - 1.4. *The seat must have a back support that is at least 12 inches (305 mm) tall; and*

- 1.5. The seat must have an occupant restraint for use by the occupant of the seat and the restraint must meet the standards for operable controls in compliance with Section 1138A.4.4.*
- 2. Be capable of unassisted operation from both the deck and water levels.*
- 3. Be stable and not permit unintended movement when a person is getting into or out of the seat.*
- 4. Be designed to have a live-load capacity of not less than 300 pounds.*
- 5. Be positioned so that, if the pool has water of different depths, it will place the operator into water that is at least 3 feet (914 mm) deep.*
- 6. Be capable of lowering the operator at least 18 inches (457 mm) below the surface of the water.*

POOL. *A constructed or prefabricated artificial basin, chamber or tank intended to be used primarily by bathers, and not for cleaning of the body or for individual therapeutic use.*

**SECTION 1142A
ELECTRICAL RECEPTACLE,
SWITCH AND CONTROL HEIGHTS**

1142A.1 Receptacle heights. *Electrical receptacle outlets on branch circuits of 30 amperes or less and communication system receptacles shall be located no more than 48 inches (1219 mm) measured from the top of the receptacle outlet box nor less than 15 inches (381 mm) measured from the bottom of the receptacle outlet box to the level of the finished floor or working platform. If the reach is over a physical barrier or an obstruction (for example, a kitchen base cabinet), receptacles shall be located within the reach ranges specified in Section 1138A.3. Physical barriers and obstructions shall not extend more than 25 inches (635 mm) from the wall beneath the receptacle.*

Receptacle outlets that do not satisfy these specifications are acceptable provided that comparable receptacle outlets, that perform the same functions, are provided within the same area and are accessible.

Exceptions:

1. *Receptacle outlets installed as part of permanently installed baseboard heaters are exempt.*
2. *Required receptacle outlets shall be permitted in floors when adjacent to sliding panels or walls.*
3. *Baseboard electrical outlets used in relocatable partitions, window walls or other electrical convenience floor outlets are not subject to the minimum height requirements.*
4. *This section shall not apply to existing buildings when the enforcing agency determines that compliance with these standards would create an unreasonable hardship.*

1142A.2 Switch and control heights. *Controls or switches intended to be used by the occupant of the room or area to control lighting and receptacle outlets, appliances, alarms or cooling, heating and ventilating equipment shall be located no more than 48 inches (1219 mm) measured from the top of the outlet box nor less than 15 inches (381 mm) measured*

from the bottom of the outlet box to the level of the finished floor or working platform. If the reach is over a physical barrier or an obstruction (for example, a kitchen base cabinet), switches and controls shall be located within the reach ranges specified in Section 1138A.3. Physical barriers or obstructions shall not extend more than 25 inches (635 mm) from the wall beneath a switch or control.

Switches and controls that do not satisfy these specifications are acceptable provided that comparable controls or outlets, that perform the same functions, are provided within the same area and are accessible.